



BYD F7-1, F7-2, F7-3 Owner's Manual



BYD AUTO Sincere Service Commitment

Dear Customers,

Because of your concern, some of our services have higher standard than the industry; because of your suggestions, we constantly pursue better service. In order to provide you with excellent services, we are committed to:

1. Smile is on my face and passion is in my body all the time;
2. I will give you a clean environment for rest;
3. I will welcome you immediately when you enter into the store;
4. I will evaluate the machine repair items before maintenance; give the final price of maintenance item immediately; perform the new items after your confirmation; before checking out, I will check one by one again with you;
5. I will estimate the maintenance time and follow up closely; in case of any delay, I will inform you immediately. If you want to check the maintenance progress, I will replay to you within 10 minutes;
6. In the maintenance process, I will use six sets of interior protection and three sets of exterior protection for your car;
7. Provide genuine original parts, and do not mix the false with the genuine;
8. Whether you have any questions or needs, I will reply as soon as possible;
9. I will pay a return visit in three days to ensure the normal driving of your car;
10. Any suggestion or advice is appreciated. I will record each of your complaints, and address actively.

Version 201203

Copyright © BYD AUTO

Without written permission of BYD AUTO

It is prohibited to reproduce or copy any or the content of the manual

All rights reserved





Whole-vehicle Performance Parameters of BYD F7

Product Model and Name		F7-1	F7-2	F7-3
		MT	MT	DCT
Dimensions	K×W×H mm (millimeter)	4860×1825×1463		
Wheelbase	Mm (millimeter)	2745		
Track	Mm (millimeter)	1555		
Tire Size		205/60R16 215/50R17		
Approach Angle (full load)	° (degree)	14		
Departure Angle (full load)	° (degree)	16		
Front/Rear Overhang	mm (millimeter)	1025/1090		
Passengers		5		
Maximum Gradeability	%	35		
Maximum Speed	km/h (kilometer/hour)	185	200	
Engine Model		BYD483QB	BYD476ZQA	
Pattern		In-line 4-cylinder, water cooled, dual overhead cam	In-line 4-cylinder, turbocharged, direct fuel injection, dual overhead cam DOHC	
Displacement	ml (milliliter)	1991	1497	
Maximum engine net power	(kW/rpm)	95/5800	104/5400	



BYD F7-1, F7-2, F7-3 Owner's Manual

Rated Torque	(kW/rpm)		172/ 4300	230/2200		
combined fuel economy	L/100km		9.3	8.8	8.5	
Emission Level			Euro IV	Euro IV		
Quality Parameters (kg)	Curb Weight		1500	1500		
	Maximum Allowable Total Mass		1975	1975		
	Distribu tion of Axle Load	No load	Front axle	880	885	
			Rear axle	620	615	
	Full load	Front axle	1000	1005		
Rear axle		975	970			
Dynamic Wheel Balancing Requirement			After attaching balance weight on each side of the wheel assembly, the measured imbalance should be less than 5g			



Preface

Thank you for choosing BYD F7. For better use and maintenance, please do read this manual carefully. If you have any question, please contact BYD sales and service station for help. For details, please visit <http://www.bydauto.com.cn/service/manual/index.php>.

BYD F7 adopts electrical fuel injection (EFI) engine. The wiring harness is complicated, so, without permission, please do NOT add electrical appliances such as anti-theft systems, audio equipment, xenon headlights, etc. to the AUTO; also use genuine original parts of BYD; otherwise the failure caused by it will not be covered by the "Warranty" of BYD; to avoid losses caused by vehicle accidents, we recommend that you cast the "spontaneous combustion insurance" and "robbery and theft insurance". Meanwhile, in order to better protect your car and avoid the loss of valuables, do not put valuables in the car.

This manual is intended to help you use the product properly and does not represent any instructions on the product configuration. For product configuration, please refer to contracts related to this product (if any) or contact the seller. The illustrations provided in this manual are for reference only. Actual auto may differ in appearance.

BYD Auto Co., Ltd. reserves the right for revising technical characteristics and contents of this manual without prior notice.

Please follow strictly the instructions where "Safety Friendly Tips" and "Auto Damage" are indicated in this manual to avoid the possibility of injuries or damages.

The notice types and their purposes are as follows



Friendly Tips

Precautions to avoid vehicle damage or personal injury

Warning

Precautions to be followed to make maintenance easier

Safety Sign

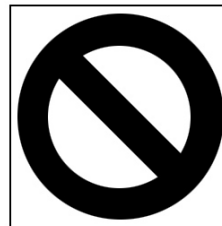

The safety sign indicated by the figure above means "Do NOT do so" or "Do NOT let it happen".

Thank you for choosing BYD F7. Your valuable comments and proposals will be warmly welcomed. To provide you with better services, please provide accurate contact information. In case of any changes, please contact BYD sales and service station for update; please register and get the license as soon as possible, and pay close attention to relevant national laws and regulations.

For car usage information exchange, please visit BYD Auto Club forum: <http://club.bydauto.com/bbs/>



Contents

Chapter 1 Instrument and Controller Operation.....	1-1
Chapter 2 Driving Tips	2-1
Chapter 3 Starting and Driving.....	3-1
Chapter 4 Exterior Maintenance.....	4-1
Chapter 5 Maintenance Notice.....	5-1
Chapter 6 Self Maintenance.....	6-1



Vehicle Identification of BYD F7 Vehicle Identification Number

Several vehicle identification number labels are pasted respectively on the vehicle.

1. Engine model/engine number is printed on the engine block.
2. The transmission number is on the nameplate at the top of the transmission.

Do not confuse the transmission number and engine number.

483QB engine

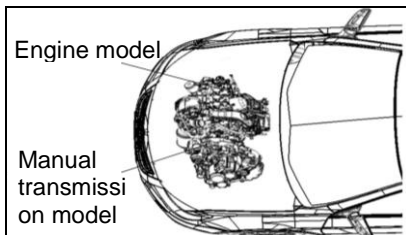
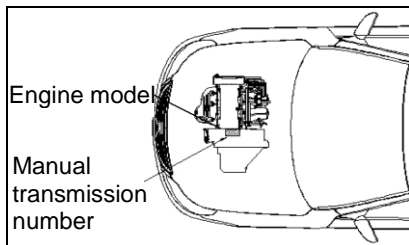

476ZQA engine

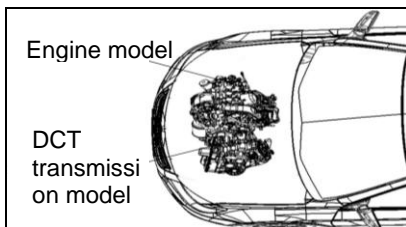

3. The vehicle identification number (VIN) is marked on the rear partition of the engine compartment and the nameplate above the instrument panel in the lower left of the front windshield.

The vehicle nameplate is nailed on the support of the left front shock absorber, and is marked with the vehicle identification number (VIN), engine type, vehicle type, engine displacement, maximum design mass, date of manufacture, etc.

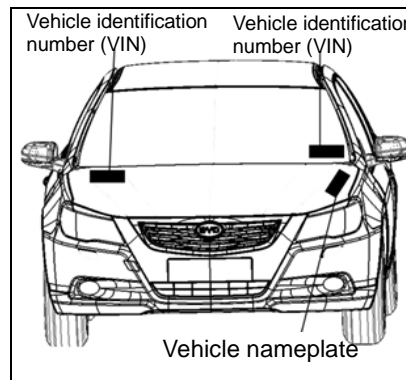

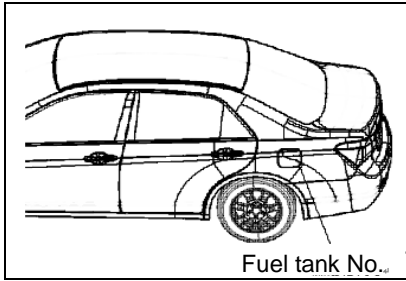

The fuel grade sign is pasted inside the filler cap

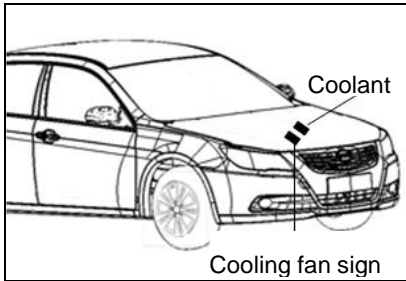

The cooling fan sign and engine coolant replacement sign are pasted inside the engine room

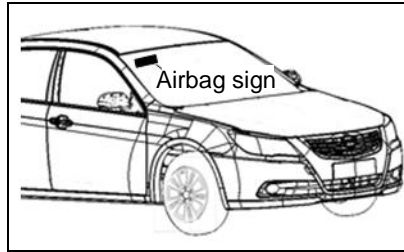

Airbag sign is pasted on the right sun visor

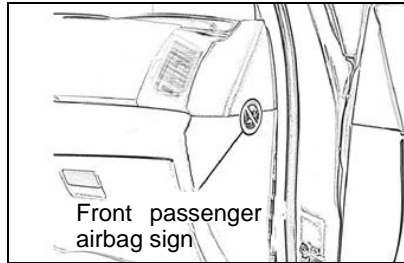

Front passenger airbag sign is pasted on the right of upper guard panel of the instrument panel

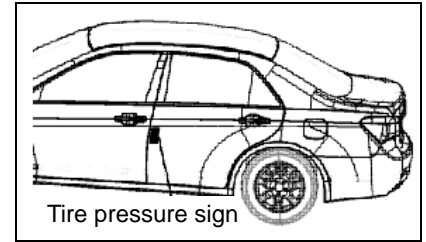

Tire pressure sign is below the left B column

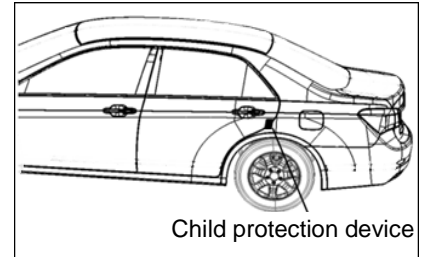

Child protection device sign is pasted below rear door striker



Chapter 1

Instrument and Controller Operation

Combination Instrument.....	1-2
Keys.....	1-5
Doors.....	1-12
Seats.....	1-13
Seat Belt.....	1-22
Airbag.....	1-24
Steering Wheel.....	1-30
Electric Rearview Mirror.....	1-31
Sunroof.....	1-33
Left Info Display.....	1-34
Right Info Display.....	1-35
Automatic Air-conditioner Panel.....	1-42
Parking Assistant Module (optional)	1-44
Parking Imaging System (optional)	1-47
Cigarette Lighter Note	1-49
Fatigue Warning System (optional).....	1-49



Chapter 1 Instrument and Controller Operation

Combination Instrument

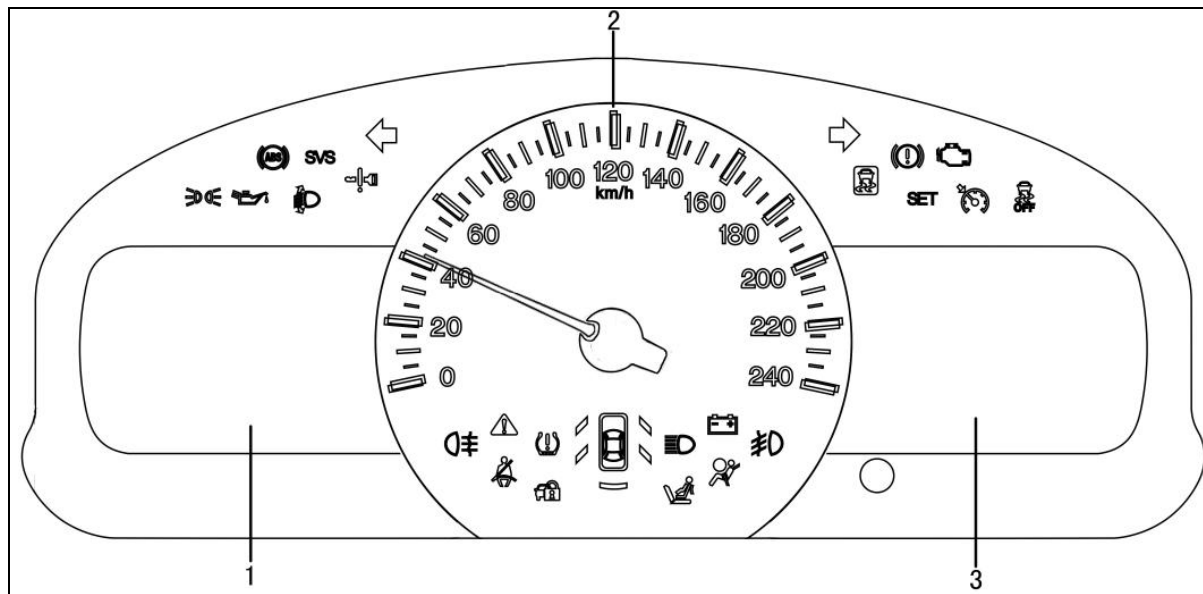





















1. Left info display





2. Speedometer

3. Right info display

Indication Signs on the Combination Instrument

	Braking system warning light *		Door and luggage compartment status indicator *
	Driver's seat belt indicator *		SRS warning light *
	Charging system warning light *		Front passenger's airbag working indicator (optional)
	Low engine oil pressure indicator *		Side light indicator
	Engine fault indicator *		High beam indicator
	Intelligence key system warning light *		Steering indicator
	ABS system warning light *		Tire pressure warning light (optional) *
	High coolant temperature warning light*		Rear fog light indicator
	Electronic control system warning light *		Low fuel level warning light
	Vehicle stability control system warning light (optional) *		Main cruise indicator light (optional)



	ESP OFF warning light (optional)	SET	Cruise control indicator light (optional)
	Anti-theft indicator		Headlight adjustment indicator *
	Main alarm indicator		

The items marked with “*” are maintenance prompt indicators; when illuminated, please park and check immediately, and contact BYD sales and service station if necessary.

Keys

F7 is provided with three types of keys: remote control key, key card and hanging key. Each key contains intelligence key and mechanical part (the mechanical part of the hanging key is in the inside, and the shell should be opened to take it out)



Remote control key

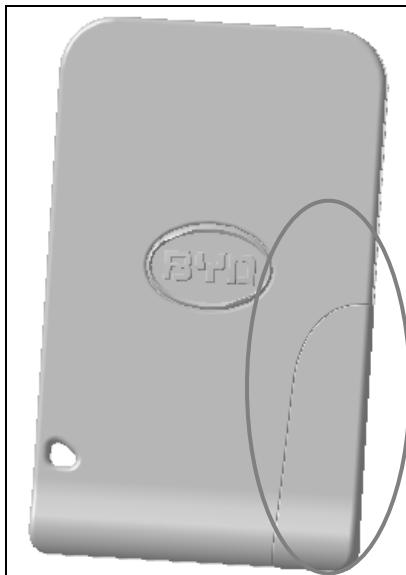

Key card

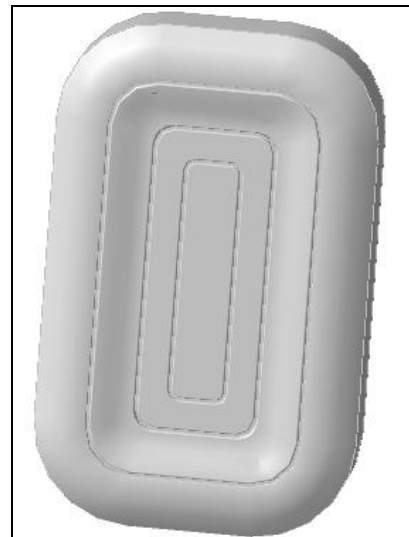

Hanging key

Warning

Obey the following precautions when use the intelligence keys:

- **People implanted with cardiac pacemakers or cardiac defibrillators**

should stay away from the antenna of smart entry and starting system, because the electromagnetic waves will affect the normal use of such devices.

- In addition to implanted cardiac pacemakers and cardiac defibrillators, people should also consult the manufacturer for the information of electromagnetic wave influence when use other electronic medical devices. The electromagnetic wave may cause unpredictable consequences to such medical devices.
- Do not attach any object that may cut off the electromagnetic waves (e.g. metal seals)
- Do not knock at other objects with the intelligence keys.
- Do not put the intelligence keys under high temperature for a long

time, e.g. instrument panel or engine hood under direct sunlight.

- Do not immerse the intelligence keys in water or wash in ultrasonic scrubber.
- Do not put the intelligence keys together with devices that emit electromagnetic waves, e.g. mobile phone.

Key number plate

The key number is indicated on the number plate; please keep the number plate properly; do not put it in the car.

If you have lost the key or need a spare key, please provide the key number and ask BYD sales and service station to copy the key. BYD recommends that you write down the key number and store it in a safe place.

Wireless remote control

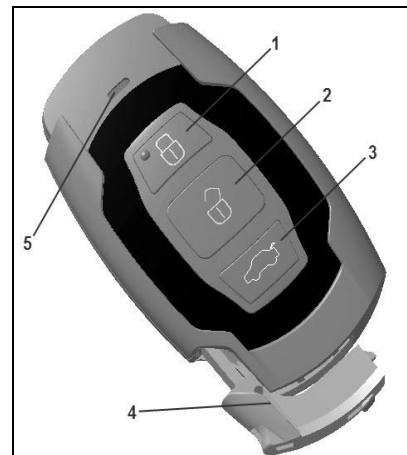

Intelligence key

1. Locking switch
2. Unlocking switch
3. Luggage compartment unlocking switch
4. Mechanical key
5. Indicator light

The wireless remote control system is designed to lock/unlock all side doors and achieve additional functions in the distance of about

1m (meter) from the vehicle; only valid for intelligence key.

Intelligence key is an electronic component. Please follow the instructions below to avoid damaging the key.

- Do not put the key at any place with high temperature, e.g. the instrument panel.
- Do not disassemble the key.
- Do not knock at other object with the key or drop it onto the ground.
- Do not immerse the key in water.

If the intelligence key can't operate in normal distance, or the indicator light is dim or off:

- Check whether there is radio station or radio transmitter of the airport that interferes with the normal operation of intelligence key.
- The battery may be run out. Check the battery in the intelligence key.

If you have lost the intelligence key, please contact BYD sales and

service station as soon as possible to avoid your car being stolen or accidents.

Locking operation

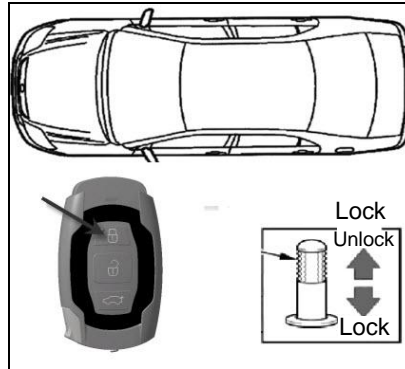

Unlocking operation

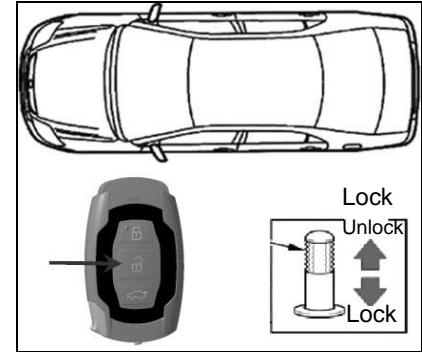

To lock/unlock all doors, press the switch on the key slightly.

Locking: Press the locking switch to lock all the doors. At this moment, the steering signal lamps flash once. Check whether all doors have been locked. If one of the doors isn't closed, it is unlocked immediately after locked with the locking switch, and the annunciator sounds once.

Unlocking: Press the unlocking switch to unlock all doors, and the steering



lamps flash twice.

Intelligence key controls the glass lifting of the four doors

1. Press and hold the remote control locking key for three seconds and the glass of the four doors ascends automatically; release the key, and the glass stops moving.
2. Press and hold the remote control unlocking key for three seconds and the glass of the four doors descends automatically; release the key, and the glass stops moving.

If the indicator of "Start/Stop" is orange, the doors can't be locked/unlocked with the locking/unlocking switch. When unlock all doors with the key, the lamps in the car illuminate for 15 seconds and then go out, even if the doors aren't opened. After using the unlocking function of

the intelligence key, please open any of the doors in 30 seconds, or else all doors will be locked again. If you press and hold the locking or unlocking switch, the locking or unlocking function won't be repeated. You need to release and press the switch again.

Car locating operation

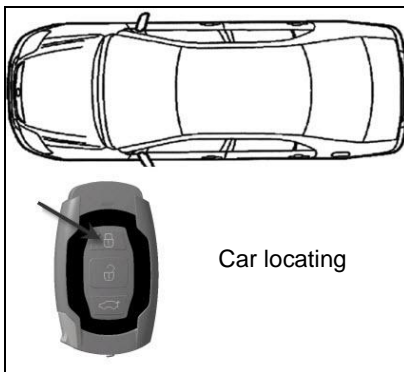

When the vehicle is in security state, press the locking switch, and the vehicle sounds and the steering lamps flash for 15 times. If you can't confirm

the location of the vehicle, please use this function to locate the vehicle. When the vehicle is in locating state, press the locking switch again, and re-enter the locating state.

Luggage compartment switch

Press and hold the luggage compartment unlocking switch for 1.5sec to open the luggage compartment, and the steering lamps flash twice.

Using luggage compartment micro switch

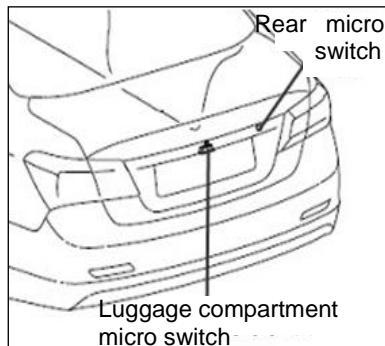

Locking/unlocking operation:

1. Unlocking: carry the valid key and press the rear micro switch to unlock all doors, and the luggage compartment is unlocked; you can press the luggage compartment micro switch to open the luggage compartment;
2. Locking: cover and lock the luggage compartment, press

the rear micro switch to lock all doors, and the luggage compartment is also locked; at this moment, the luggage compartment can't be opened with the luggage compartment micro switch.

Intelligence key entry and starting function Entry function— lock/unlock the doors

Press the switch on the key to lock/unlock all doors.

Press the locking switch to lock all doors.

At this moment, the exterior rearview mirrors are folded, and the steering lamps flash once. Check whether all doors are locked firmly.

Starting function— if the intelligence key is in the car, you can use it to switch the power mode and start the engine.

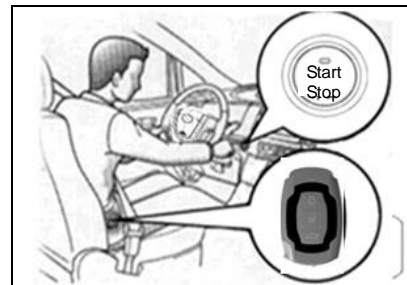

With the intelligence key, you can lock/unlock the doors and start the engine.

Steering lock function

When use wireless remote control or micro switch to lock the doors, the steering wheel also will be locked. You can press the "Start/Stop" switch to release the steering lock automatically. If the green indicator on the "Start/Stop" switch flashes, the steering lock is stuck. To release it, shake the steering wheel while pressing the "Start/Stop". If the orange indicator flashes, the steering lock has fault. Please ask BYD



sales and service station to check the vehicle.

Activation region

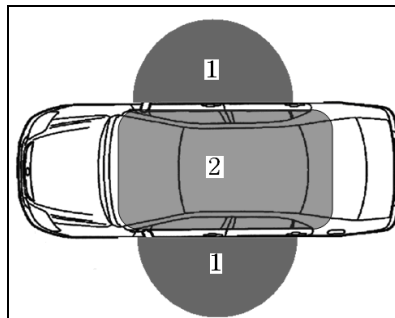

The entry function and starting function are available when the registered intelligence key is in activation region.

Entry function activation region — within 1m (meter) from the micro switch of the front outside door handle. If the intelligence key is too close to the door handle or

window, the entry function may be not activated.

In the following cases, the smart entry and starting system may be unable to work normally.

- If facilities that release strong electromagnetic waves exist nearby, such as the TV tower, power station, radio station, signal tower.
- When the intelligence key and communication device are carried together, such as two-way radio communication equipment or mobile phone.
- When the intelligence key contacts with or is covered by metal objects .
- When operate door handles quickly.
- When the intelligence key approaches the door handle.
- When other people in another vehicle nearby is operating the wireless remote control.

- When the intelligence key is near high voltage equipment or equipment that produces noise.
- When the intelligence key is carried together with the key of other smart entry and starting systems or other devices that emit radio waves. Even in the active region, due to the smart key position or body shape, smart key also may not work properly.

If the smart entry and keyless starting system doesn't work normally and can't enter the car, use the mechanical key attached to the electronic intelligence key to lock/unlock the door on driver's side, or use the wireless remote control to lock/unlock all doors.

When the intelligence key of other vehicles approaches the intelligence key of this car, the time of unlocking will be longer; however, it is not a fault.



The exterior rearview mirror, footwell light and rear roof lamp will illuminate/go out automatically according to the existence of intelligence key, door locking/unlocking, door opening/closing and power position.

If the battery of the intelligence key is used up (vehicle is started in power down mode), start the engine in the following step:

1. Step on the brake pedal or press the "Start/Stop" switch, the warning light of smart entry and starting system is illuminated and the buzzer in the vehicle rings once.
2. In seconds after the buzzer rings, approach the electronic intelligence key to the "Start/Stop" switch, the buzzer will ring once again to prompt that the engine can be started.

3. Start the engine in five seconds after the buzzer rings again.

Warning

If the indicator of the intelligence key doesn't flash, and the engine can't be started with the starting function, the battery may be used up. Please replace the battery as soon as possible.

Saving battery power

Even if you aren't driving the car, the key and the car also can communicate. Therefore, do not leave the key near the car (within 2m).

If the car isn't used for a long time, the battery may be used up. To prevent battery being used up, disconnect the negative terminal of the battery.

To reactivate smart entry and starting system, please take one of

the following methods:

- When carry the intelligence key, press the micro switch of the front outside door handle.
- Perform wireless remote control operation.
- Insert the mechanical key into the key hole in the door on driver's side and turn the key.

If the intelligence key has been receiving strong electromagnetic waves for long time, the battery will be used up quickly. The intelligence key should be kept at least 1m away from the following devices.

- TV set
- PC
- Wireless phone charger
- Electrolier
- Fluorescent lamp

If the smart entry and starting system can't work normally due to system fault, please contact BYD sales and service station. Please carry all intelligence keys, which

may be necessary for the repairing.

Warning

- Without permission, do not alter the emission frequency, increase the emission power (including but not limited to adding emission frequency amplifiers), equip external antennas or use other emission antennas.
- Use of the intelligence key should not produce any harmful interference to any legal wireless communication services; stop use of the intelligence key immediately if any interference is found and do not use it until measures have been taken and the interference has been eliminated.

- To use micro-power radio equipment, you have to endure the interference of the various radio services or radiation interference of industrial, scientific and medical devices.
- Do not use the intelligence key near aircrafts or airports.

Doors

Locking operation

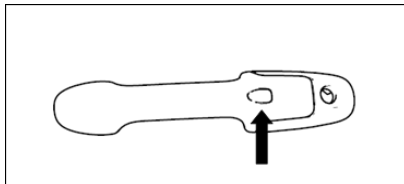

Press the micro switch button of the outside door handle slowly and firmly, all doors are locked at the same time, and the steering lamps flash once. In the following cases, the doors won't

be locked when you press the micro switch.

- Certain door isn't closed
- Press the locking button while opening or closing the door
- The engine isn't shut down
- The power of the car isn't cut off normally (the indicator of "Start/Stop" key is orange).
- The key is left in the car

Unlocking operation

Press the micro switch button of the outside door handle slowly and firmly, all doors are unlocked at the same time, and the steering lamps flash twice. After using the unlocking function, open a door in 30s, or else all doors will be locked again.

Automatic locking of doors

When the vehicle speed exceeds 20km/h, all doors will be locked automatically.

Rear-door child protection lock

The child protection lock is designed to prevent the child in the rear seat from

opening the rear doors unconsciously. Each rear door is equipped with a door latch in the side. When this latch is in LOCK position, the doors can't be opened from inside, no matter where the holding button is. To open the doors, use the outside door handles.

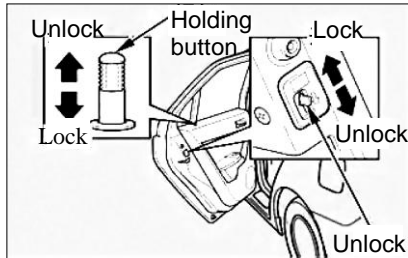

Warning

Before actuating the auto, especially when there is any child in the car, please make sure the door is closed and locked. Correct seat belt use and door lockup is helpful to prevent the driver and passengers from being thrown out in case of accidents and prevent unexpected opening of the doors.

Anti-theft system

Enter security state

- Shut down the engine;
Let all the passengers get off;
Lock all doors.

When all doors are locked, the anti-theft indicator is illuminated. After 10 seconds, the anti-theft system will be set automatically, and then the anti-theft indicator starts flashing.

- Leave the car when the indicator starts flashing.

Since the system will be activated if the

door is opened from inside, do not let anybody stay in the car when setting the system.

Activating alarm

In the following cases, the system will alarm:

- Unlock any of the doors without the intelligence key entry function.
- The car is powered on without the intelligence key starting function.

Canceling security state

Stop the alarm in the following method:

- Use wireless remote control to unlock the doors.
- Use micro switch to unlock the doors.

Seats

Warning

- **Seat belts can provide the maximum**

protection in collision accidents if the driver and passengers sit straight and lean on the seat backs. If you lean on the seat back obliquely, the seat belt part for the waist may slide over your hip and directly exerts pressure on your belly. In front-collision accidents, over obliquity of the seat may increase the risk of human injuries.

- Do not drive the car before all passengers have been properly seated. Do not sit on the upper back part of a folded seat or on trunk or baggage. In case of emergency braking or collisions, passengers who haven't sat properly or buckled up may be seriously injured.
- While driving, do not let

passengers stand up or move among seats; otherwise, they may be seriously injured in emergency braking or collisions.

- Do not adjust the seat when the car is driving, since sudden movement of the seat may lead to auto control failure. In seat adjustment, take care to avoid collision between the seat and passengers or baggage.
- After the seat is adjustment, make sure it is locked up at its position.
- After seat adjustment, lean backward to see whether the seat back is locked up at its position.
- Do not place things under the seat; this may affect the seat lockup mechanism and lead to some movement of the

seat, causing auto control failure.

- For seat covers, BYD approved covers are recommended; please install under the guidance of the service station, or else the seats, airbag system and seat belt system can't work normally.

Driver's power seat adjustment (optional)



Seat position, seat cushion angle and seat height adjustment switch

Please move the control switch along desired direction and adjust the seat state.

Rear seats

Rear seat handle is located between the rear seats. Tip it over if necessary. The luggage compartment channel cover can be opened from inside, and is folded forward on the center handle. To open it, lift and pull open the handle.

Ensure all the items in the luggage compartment or the items extending from the opening to the rear seats are fixed. Do not drive the car when the luggage compartment channel cover and luggage compartment lid open.

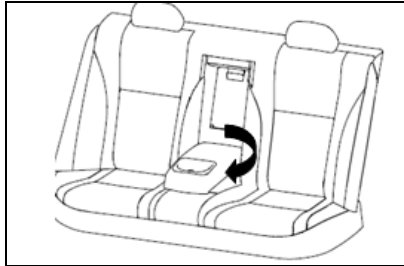

Child seat protection device

BYD strongly recommends that you use child protection device.

Friendly Tips

- **The study shows that it is safer to correctly protect children in the rear seat than in the front passenger's seat.**
 - **Select appropriate child protection device according to the age and body shape of the child.**
 - **For installation details, please refer to the manual of the child protection**

device.

Type of child protection devices

The child protection devices are classified into three types according to the ages and body shapes of children.

1. Baby (infant) seat

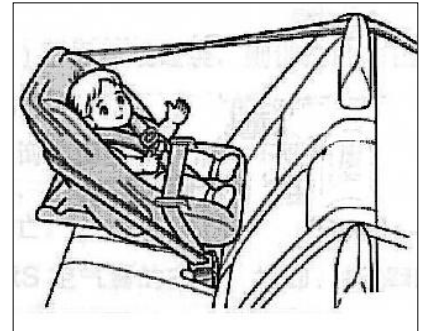

2. Child (convertible) seat

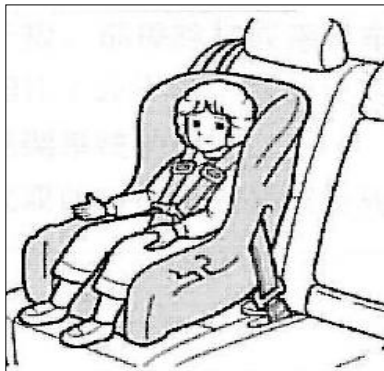

3. Youth (auxiliary) seat



If the child protection device isn't used

Please fix the child protection device on the seat properly. Do not put the device on the passenger's seat or in the luggage compartment.

Please select a set of appropriate child protection devices

Please select a set of appropriate child protection devices for your child. If the body size of the child is too large and can't use the child protection device, sit on the rear seat and use the seat belt.

Installing child protection device

Please follow the installation instructions provided by the manufacturer of the child protection device. Fix the child protection device on the rear seat with the seat belt or lower fastening belt of the child protection device. Fix the top belt when install the child protection device.



Seat belt equipped with child protection device locking mechanism (rear seat ALR/ELR seat belt)

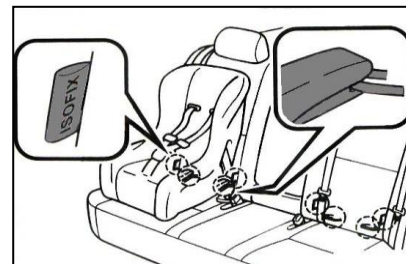

ISOFIX rigid anchor (ISOFIX child

protection device): the outer rear seat is provided with fixing rod (the label showing the anchor position is attached on the seat)

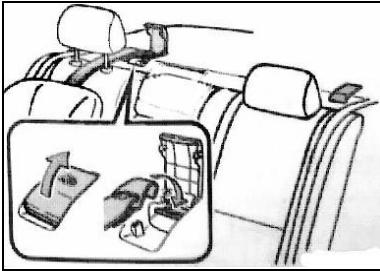

Anchor support (for top belt): the outer rear seat is provided with anchor support.

Install child protection device with seat belt (child protection device locking seat belt)

1. Rear-facing to child seat - baby (infant) seat
/Child (convertible) seat: install the child seat on the rear seat and keep it facing to the rear.

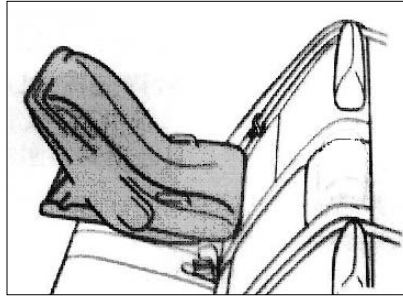

Thread the seat belt through the child's seat and insert into the buckle. Ensure that the seat belt isn't twisted.

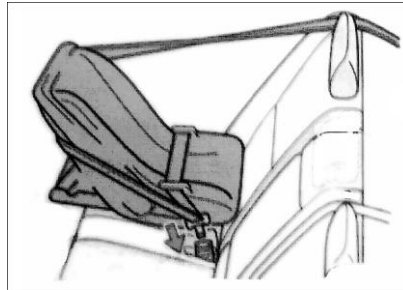

2. Forward-facing - child (convertible) seat
Install the child's seat on the seat and

keep it facing to the front.

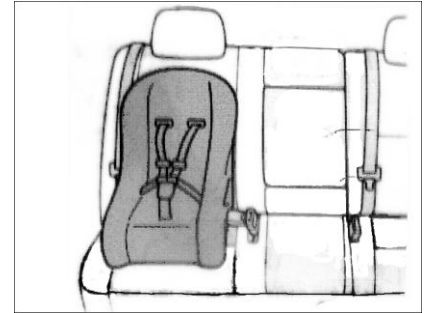

Thread the seat belt through the child's seat and insert into the buckle. Ensure that the seat belt isn't twisted.

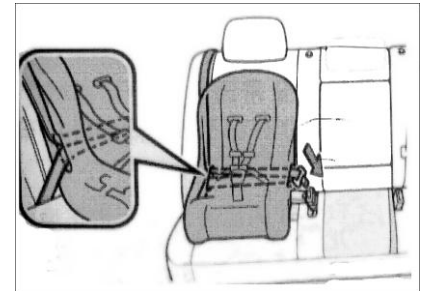



Fully pull out the shoulder belts, and then make it slightly retract and enter lockdown mode. In locking mode, only the seat belt can be retracted.

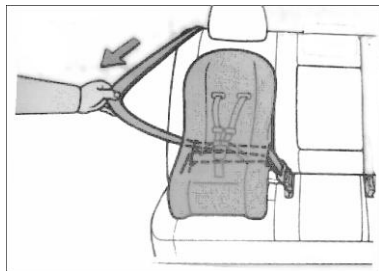

Put the child's seat on the rear seat, and fully retract the shoulder belt until the child's seat is fixed. When the shoulder belt is fully retracted, pull the seat belt to make sure that it can't be pulled out.

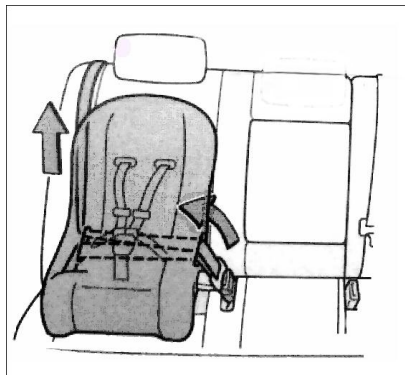

Youth (auxiliary) seat

Install the child's seat on the seat and keep it facing to the front.

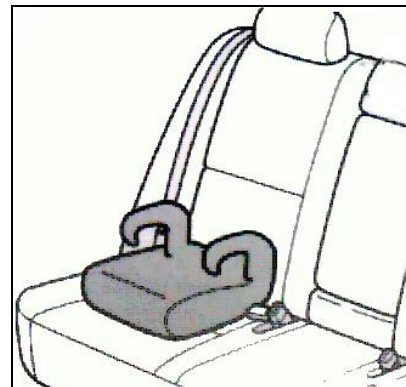

Let the child sit on the child's seat. Fix the child's seat with the seat belt according to the installation instructions of the manufacturer, and insert the belt into the buckle. Ensure that the seat belt isn't twisted. Check and make sure that the shoulder belt crosses the child's shoulder, and the waist belt should be as low as possible.



Remove the child protection device installed with seat belt
Press the buckle release button to fully retract the seat belt.

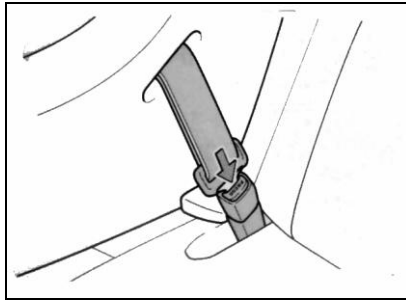

Install the child protection device with ISOFIX rigid anchor (ISOFIX child protection device)

Check the position of the special fixing rod, and install the child protection device on the seat. The fixing rod is installed in the gap between the seat cushion and backrest.
If the child protection device is provided with top belt, fix the top belt on the anchor.

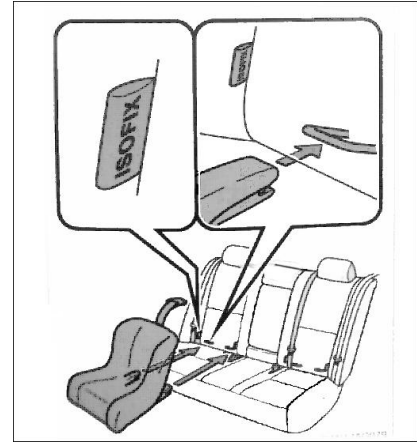

Child protection device with top belt

Fix the child protection device with seat belt or ISOFIX rigid anchor and remove the headrest.

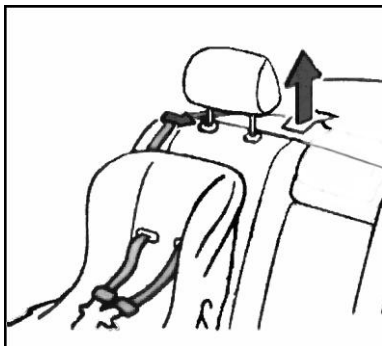

Open anchor support cover, fix the hook to the anchor support and tighten the top belt.

Ensure that the top belt is fastened.

1. Hook
2. Top belt
3. Anchor support

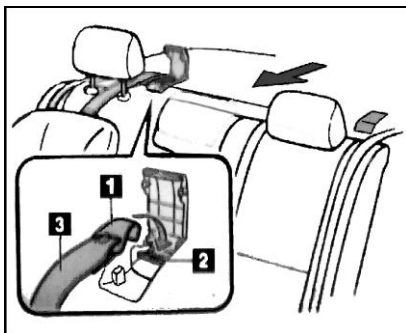

Reinstall the headrest.

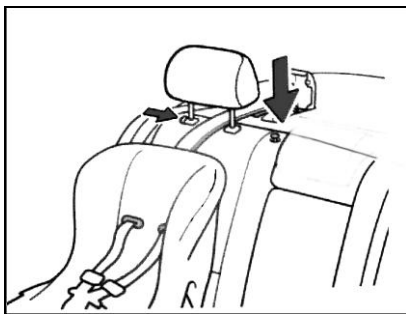

When the child protection device is

installed on the front passenger's seat

If the child protection device should be installed on the front passenger's seat with locking buckle, please follow the instructions of the manufacturer of child protection device.

Warning

Do not stretch the shoulder belt completely to prevent seat belt entering locking mode.

- In this mode, the seat belt only can be tightened, which will make the child get hurt or feel uncomfortable.
- Do not let the child play with the seat belt, or else it may result in serious injury or even death of the child.
- When install the child protection device, please follow the instructions of the manufacturer and fix the device in place;

otherwise, it may result in serious injury or even death of the child when emergency braking or accident occurs.

When installing youth (auxiliary) seat

1. If the driver's seat obstructs the proper installation of child protection device, install the device on the rear right seat.

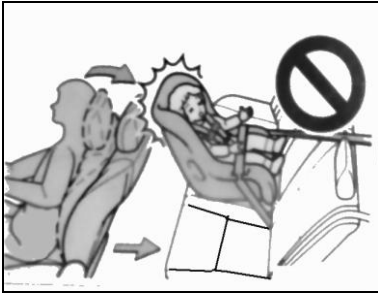

2. Install the forward-facing child seat or youth (auxiliary) seat on the front passenger's seat only

when necessary; while installing, move the seat backwards, or else it may result in serious injury or even death when the airbag expands (inflates).



When installing child protection device

Never install rear-facing child protection device on the front passenger's seat.

Otherwise, when accident occurs, the rapid expansion of front passenger's airbag may result in serious injury or even death of child.

1. The instrument panel on the

passenger's side is attached with warning label, which reminds you that do not install the rear-facing child protection device on the front passenger's seat.

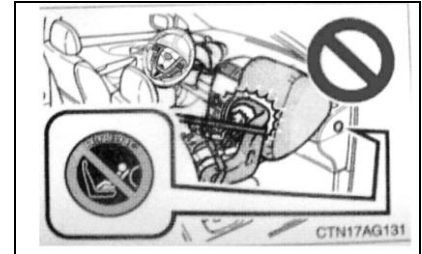

2. When install youth (auxiliary) seat, ensure that the shoulder belt crosses the middle part of the child's shoulder. The seat belt should be kept away from the child's neck, but shouldn't slip off from the shoulder easily. Otherwise, it may result in serious injury or even death of the child in case of emergency braking or accidents.
3. Ensure that the seat belt and belt



end are fixed, and the seat belt isn't twisted.

4. Push the child's seat to different directions and ensure that it is fastened.
5. Please follow the installation instructions of the manufacturer of the child protection device.

Fix the child's seat on the anchor properly

When use lower anchor, make sure that there is no foreign matter around the anchor device and the seat belt isn't clamped behind the child's seat. Make sure that the child protection device is fixed, or else it may result in serious injury or even death in case of emergency stop or accident.

Seat belt

The driver should adjust the shoulder height of three-point seat belt to appropriate position according to passenger's body.

Length of the seat belt can be automatically adjusted according to the passenger figure and the seat position. Keep the waist belt as low as the hip as far as possible—do not buckle it at your waist. Then, tug the shoulder part upward through the catch plate and adjust the seat belt to an appropriate position.

If the seat belt cannot smoothly retract automatically, tug it out to see whether there is any knot or twist; if yes, please contact BYD sales and service station.

Seat belt with pretensioner (optional)

The seat belts of driver's seat and front passenger's seat, and will be activated when serious frontal collision occurs.

When the sensor detects serious frontal collision, the retractor will retract the front passenger's seat belt quickly, so that the passenger will be protected appropriately.

Even if there is no passenger on the front passenger's seat, the seat belt

pretensioner will be activated.

In case of collision, the pretensioner of the front passenger's seat belt and SRS airbag may be not activated simultaneously.

In case of collision, the seat belt pretensioner will be activated, and may cause noise and release non-toxic gas; however, it does not indicate a fire and the gas is usually harmless.

Emergency locking seat belt with child protection module (rear left/right seat belt)

To use this function, the ribbon should be pulled out completely to activate this device and enter self-locking activation state. Then, the ribbon only can be retracted in order to fix the child's seat, and the continuous click sound accompanies to indicate that the function is normal. After retracting for certain distance (about 1.1m), the sound disappears, this function is inhibited and enters self-locking state, and the ribbon can be pulled out and retracted normally (the child's seat

can't be fixed). The click sound is to remind user that the function is normal rather than fault noise!

Friendly Tips

When the child protection module of the rear seat is activated, please pull out the ribbon completely and apply appropriate force to avoid damage.

Indicator that front passenger's seat belt isn't fastened

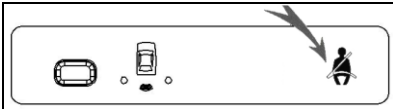

If the F7 passenger's car you purchased is provided with seat belt alarm sensor, the switch group on the central control panel of the instrument platform has an

indicator that front passenger's seat belt isn't fastened (black shaded area in above figure). It is used together with the seat belt. When a passenger sits on the front passenger's seat but doesn't fasten the seat belt, it is lit and accompanied with alarm sound to remind the driver and the passenger. When the front passenger fastens the seat belt, the indicator goes out. If no passenger sits on the front passenger's seat, the indicator is off.

Friendly Tips

- **Seat belts equipped on the vehicle are designed for adults and should be applied to children with caution.**
- **It is suggested to seat children in the rear seat with child seat and fasten the seat belt for protection. Do not let the children sit in the front passenger's seat.**
- **Do not place children on**

your knees or hold them in your arms, or else it may result in serious injury or even death of the children. Arranged in the front seat or the rear seat, children should not be allowed to stand or kneel. In emergency braking or crashes, unprotected children may be seriously injured.

- **When the vehicle is driving, passengers in it should sit in the seats and fasten the seat belts correctly; otherwise, in emergency braking or crashes, people in the car are more prone to severe injuries.**
- **At the same time, a seat belt can only be used by one person. It's not allowed that two or more persons share one seat belt—even for children.**
- **Do not incline the seat back over. The seat belt has the best protection**

effect when the seat back is in the upright position.

- Check the seat belt regularly to see whether it has cutting lines, worn or loose parts. Damaged parts should be replaced with new ones; the system should not be disassembled or modified.
- After serious crashes, the seat belt system (including screws) should be replaced, even if the damage is not so marked. When the spring bolt is inserted, make sure that the spring bolt and buckle are fixed and the seat belt isn't twisted.
- Do not leave small objects, e.g. coins, paper clips, etc. in the buckle. They may affect the connection of the tab and the buckle.
- If the seat belt functions abnormally, immediately inform BYD authorized service stations. Before

repaired, it cannot protect passengers.

- Keep a straight posture and stay back, keep a proper distance with the steering wheel and instrument panel, so as to play the maximum protective effect of seat belt and SRS.
- It should be made sure that the shoulder seat belt passes over the shoulder center.
- The seat belt should be somewhat far away from the neck without sliding off the shoulder. Otherwise, its protection effect may be reduced and severe human injuries may be caused in crash accidents.

Airbag

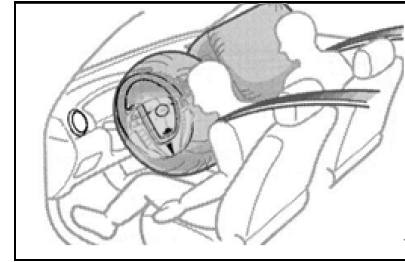

Airbag is the supplemental restraint system, which is a supplement to seat belts. The airbag system can provide extra protection for heads and chests of the driver and passengers and reduce casualties in severe frontal crashes.

Friendly Tips

- Please keep the seat belt fastened when the vehicle is driving!
- Please keep sitting in a correction posture so that the protection effect of the seat belt and the airbag system can be taken into full play.

- **For children, the rear seats are the safest position!**
- **Do not dismount parts of the airbag without permission!**

Airbag triggering conditions

The airbag is designed to be triggered under the following conditions: frontal (side) collision accidents may trigger the airbag system; special collision accidents may trigger the airbag system. In general, the airbag system won't be triggered in mild front collision or side collision accidents, in rear end collisions or in turn-over accidents. In such accidents, the seat belt, if fastened, can protect the driver in the normal way.

The decisive factor for triggering the airbag system is the comprehensive intelligent comparison and judgment of the deceleration curve produced in a collision and acquired by the

electronic control unit (ECU) and the set value. If the automobile deceleration signal produced and detected in the collision is lower than the set reference value in the ECU, the airbag won't be triggered even though the car may have been severely deformed in the accident.

ECU setting of BYD airbag system takes various common misuse and domestic road conditions into full consideration. However, reasons and conditions of crashes are variable, so, for your safety, please abide strictly by this manual, use the automobile correctly and avoid misuse; otherwise, the expected protection effect of the airbag cannot be ensured.

Airbag warning light

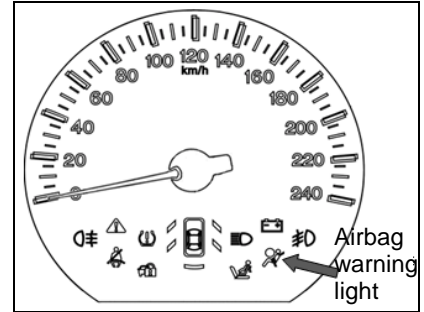

The airbag system is monitored by an electronic control unit and provided with self-diagnosis function. The system state can be indicated by a warning light on the instrument panel: Each time after the ignition switch is turned on, the airbag warning light turns on for about 5s and then goes out for longer than 5s, and the system can be considered as normal.

If the airbag has already been deactivated by a BYD authorized service station, but the warning light still turns on and goes out as above, it



means the airbag has no protection function.

Friendly Tips

In case of faults, have the airbag system checked immediately in a BYD authorized service station. Otherwise, in accidents, partial or all function of the airbag system may be affected!

Conditions that airbag may expand

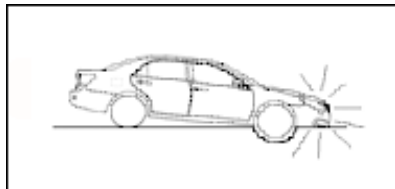

When crossing deep notch, the fronts hit the ground

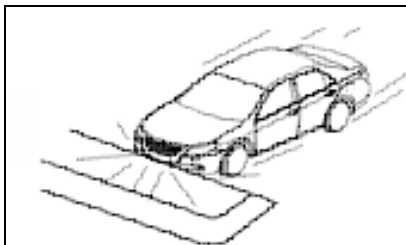

Hit the bump or street stone at roadside.

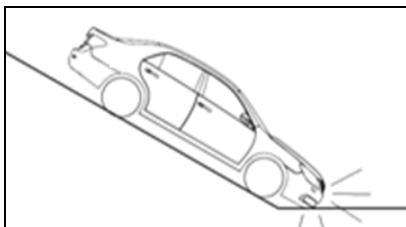

The front hits the ground when going downhill

Conditions that the airbag may not expand



Hitting on a cement pole, a tree or other slim objects

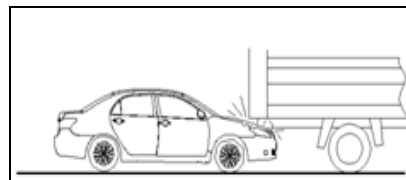

Crashing into the bottom of a truck

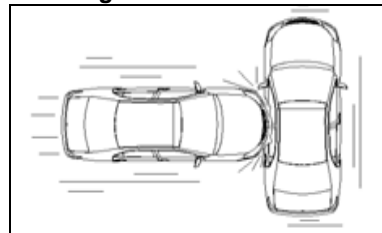

Hit by other vehicles on the side

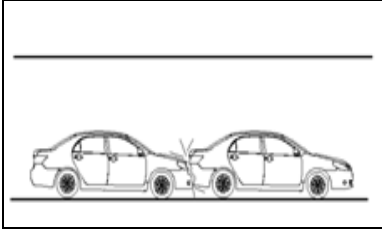

Rear Crash

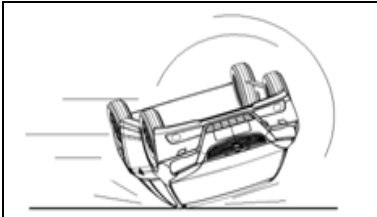

Side rollover

Warning

- The airbag is designed to match the certain vehicle models. Any changes of the suspension, the tire

size, the bumper, the chassis and other original equipment may adversely affect the function of the airbag. In addition, it is strictly prohibited to apply any airbag parts to other vehicle models; otherwise it might lead to safety airbag system failure, resulting in personal injuries.

- During driving, please wear the seat belt correctly and maintain a correct sitting posture. If you haven't worn the seat belt and lean forward or sit in an incorrect posture, the risk of injuries in accidents with airbag expansion may be increased.
- It's very important for the driver to maintain a distance of at least 25cm between the chest and the steering wheel since only by doing so can the maximum protection effect be provided when the

system is triggered.

- Do not paste or cover the surface of the steering wheel lid or the surface near the airbag on the right of the instrument panel with any objects or do any other decorative treatment. cleaned with only dry or slightly wetted cloth and should not be knocked at violently
 - Don't let child passenger sit in the front seat without protection. If a collision triggers the air bag, the child passenger may get seriously injured or even killed.
 - Telephone supports, cups, ashtrays, etc. can increase the risk of injuries in accidents with airbag inflation.
- The side airbags and side air curtains expand at fast speed and great force. In vehicles equipped with side airbags and side air curtains, never lean against the door, or else



it may result in serious injury or even death.

- Do not install other accessories or items within the effective scope of the side air curtain, such as windshield glass, side door glass, “A” pillar trim panel, roof, “B” pillar trim panel, “C” pillar trim panel and auxiliary handle, because the great force of side air curtains will shoot off the accessories or items or side air curtains can't expand, resulting in serious injury or even death.
- Do not modify or replace the trim of the seats with or without side airbags, because these changes will interfere with the normal expansion of side airbags, cause system failure or unexpected expansion of side airbags, resulting in serious injury or even death.

- Do not disassemble or repair the A pillar, roof, B pillar, or C pillar with side air curtain. These changes may cause system failure or unexpected expansion of air curtain, leading to serious injury or even death.
- Never modify any component of the air bag system, including the corresponding label. Any operation of the airbag should be performed by BYD authorized service station.
- The airbag system must be replaced in a BYD authorized service station within 10 years as of the date of manufacture. The maintenance manual has the record if certain part of the airbag system had been replaced.
- The air bag can only provide protection once. Once the air bag is triggered or damaged, the

- system must be replaced.
- Please hand our materials to the next owner of the vehicle in transfers. Please note that if the airbag is shut down, the information should be informed the next owner of as well.
- When disposing the parts of the vehicle or the airbag system, please comply with correlative safety regulations and disposal procedures.
- The air bag system has strong resistance capacity against the surrounding electromagnetic interference. However, to avoid accidents, please do not use the vehicle beyond the electromagnetic environment specified by national laws.
- The airbag system of BYD auto has taken into full consideration various kinds of misuses and road

conditions. However, avoid serious crashes happen in the bottom of the vehicle or drive toughly in poor road conditions in order to prevent accidents.

- The airbag system of BYD F7 passenger's car has been fully validated, and the original vehicle wiring harness system and the air bag system exactly match. Any modification of the vehicle wiring harness may result in unexpected expansion or failure of the expansion of the airbag.

Steering wheel switch group (optional)

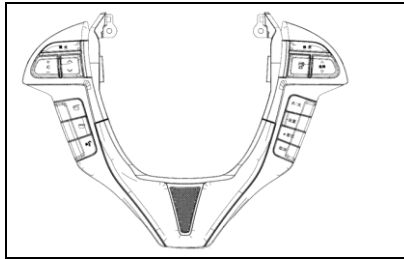

The audio control switch is available when the start button is in ACC or ON position.

Press “+” to turn up the volume
Press “-” to turn down the volume

Press “^” in radio mode: scan next available radio channel automatically (increase frequency)
In CD/USB/SD/AUX mode: play next track (track # +1);
In DVD mode: go to next chapter;

In TV mode: play next channel.

Press “v” in radio mode: scan previous available radio channel automatically (decrease frequency)
In CD/USB/SD/AUX mode: play previous track (track # -1);
In DVD mode: go to previous chapter;



In TV mode: play previous channel.
Press “MODE” to select the mode, which switches among FM→AM→CD (if disc is inserted) → DVD → TV → USB (if USB disk is connected) → AUX (if a player is connected to AUX





interface) → SD (if inserted) in sequence.

If the audio system is turned off, press MODE to turn it on and enter the playing mode when it was turned off. If there is no playing source in the playing mode (e.g. no disc or external audio device), it will switch to FM mode directly, and switch in above sequence when you press the MODE key;

Press and hold it and you can turn off the audio system.

When the start button is in ACC position, press “” to use it as the auxiliary calling and ending device of car phone for calling/answering (press this key and the audio system is mute). When the start button is in ACC position, press “” to use it as the auxiliary calling and ending

device of car phone and end the call (if the audio system is mute, the system will resume the original operation).

When the start button is in ON position, it can be used together with the 7” screen to assist the driver to check the car surrounding. When the start button is in ON position, the transmission is set to “R”, the rear camera is activated, and the display switches to the “” screen automatically. Press “” in sequence: activate the camera → right camera → rear camera → right camera → deactivate the camera.

Press “” to scroll up the instrument menu.

Press “” to scroll down the instrument menu.

Press “OK” to enter the menu.

When the start button is in ON position, the cruise switch is available and “+RES” is the speed up/reset button; “-SET” is the speed down/setting button;

“CANCEL” is cruise canceling button; “ON /OFF” is cruise control button. In ON position, press the ON/OFF button in the right of the steering wheel, and the indicator on the instrument panel is illuminated.

Steering wheel

To change the steering wheel angle, hold the steering wheel, push down the lock release lever, tilt the steering wheel to the desired angle and return the lever to its original position.

Friendly Tips

- **Do not adjust the steering wheel while the vehicle is moving. This may cause the driver to mishandle the vehicle and an accident may occur.**
- **After adjusting the steering wheel, try to move it upward and downward to make sure that it is**

locked in position.

Electric rearview mirror

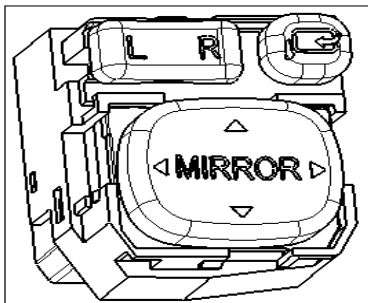

Press this switch to adjust the direction of left and right rearview mirrors.

1. Selection switch—— to select the rearview mirror to be adjusted by pressing the switch to “L” or “R”.
2. Control switch—— to adjust the rearview mirror by pressing the switch accordingly.
3. Folding switch—— to fold the

rearview mirror.

When the start button is in “ACC” or “ON” position, the mirror can be adjusted.

Warning

If the rearview mirror is frozen, do not operate the controller or scratch the surface of the rearview mirror; use spraying de-icer to remove the ice on the rearview mirror.

Interior rearview mirror (optional)

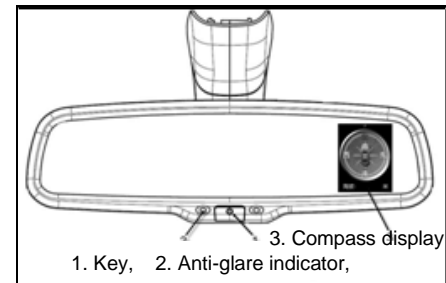

1. **Adjust the position of the interior rearview mirror to watch the rear view through the rear windshield.**
2. **The electronic anti-glare function applies to all vehicle models**

Press the power button to turn on/off the electronic anti-glare function.

- (1) Turn on electronic anti-glare function —— power indicator is illuminated, and the surface of the interior rearview mirror may have two conditions**



Daytime: the rear view is clear
Night: When the rear headlights are illuminated, the anti-flare function is turned on and the reflectivity decreases; when the rear headlights are turned off, the anti-flare function is turned off and the reflectivity resumes normal.

(2) Turn off electronic anti-glare function — power indicator is off.

It is recommended that turn off the electronic anti-flare function when reversing the car in the night.

4. Considerations of interior rearview mirror compass:



- (1) When the car is started, the electronic compass displays; when the car is flame out, the electronic compass hides;
- (2) If the reversing radar is turned on, the electronic compass hides while reversing;
- (2) The direction indicated by the front in the figure is the actual driving direction;

- (3) The altitude shows the altitude of the car; it is normal that the display error is in 50m.

Warning

- ◆ Do not adjust the interior rearview mirror while driving, or else the driver may be unable to control the car and cause accidents, resulting in injury or even death.

Manual calibration of interior rearview mirror

I. Before calibrating the direction, please note the two matters below:

1. The direction displayed by the interior rearview mirror compass is the direction of the front.
2. For calibration, select an open and flat square or closed street or ring driveway (roundabout), and confirm the directions (as shown in the figure);

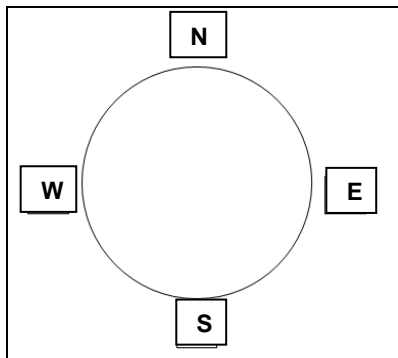

II. Calibration step

Step 1: **ignite to start**

Step 2: **select the starting position**, which may be any one of north, south, west and east.

Step 3: **press and hold interior rearview mirror key** until the upper right of the glass displays several lines of description text (calibration step description) and the anti-flare indicator flashes three times quickly (indicator illuminates and goes out once) and then release the key.

Step 4: **drive one circle (360°) or**

two circles at low speed (< 8km/h) and return to starting position (do not flame out while driving; both clockwise and counterclockwise are allowed)

Step 5: **adjust the head to “south”.**

Press the key once (release immediately), the anti-flare indicator flashes three times and the compass points to **“South”**, and the calibration finishes.

Step 6: **after calibration, drive the car for one circle** to check whether each direction is proper. If not, re-calibrate from step 1.

Sunroof

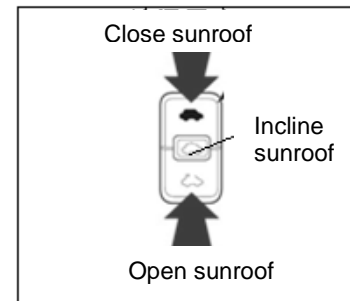

The sunroof has two positions: to ensure ventilation, lift the rear side or slide into the roof. The switch below the air outlet of the instrument panel at driver's side can be used to control the sunroof. However, the start button must be in “ON” position.

To lift the rear side of the sunroof,

press and hold ();

to close the sunroof, press and hold () in the top;

to open the sunroof, press and hold () in the bottom.



When the sunroof reaching desired position, release the switch. Before opening/closing the sunroof, make sure that the all passengers have moved their hands away from the sunroof.

Warning

- **When opening/closing the sunroof, it will cause serious injury if certain passenger's hand or finger is clamped. Before opening/closing, make sure that all passengers have moved their hands away from the sunroof.**
- **While driving, do not leave the body out of the sunroof.**

The sunroof has keyless delay function. When the vehicle power is cut off, this function still allows opening or closing the sunroof in 45 seconds. Open any front door and the delay function can be canceled

immediately. At this moment, you must switch the start button to "ON" position in order to manipulate the sunroof.

Warning

The sunroof or motor may be damaged if the sunroof is opened in the environment lower than 0°C or is covered by snow.

Left info display

The left info display includes tachometer, accelerometer, mileage, gear indication, and exterior temperature.

- **Tachometer**

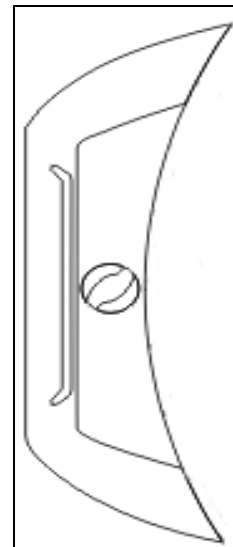

When the engine is started, the accelerometer displays the acceleration info of the car. When the car is driving at constant speed or doesn't have speed, the accelerating ball points at the center; when the car is accelerating, the ball moves upwards; when the car decelerates and

brakes, the ball moves downwards.

Right info display

The right info display includes engine coolant temperature gauge, fuel gauge, backlight adjustment position prompt, adjustment menu, driving info, prompt and fault info.

● Engine coolant temperature gauge

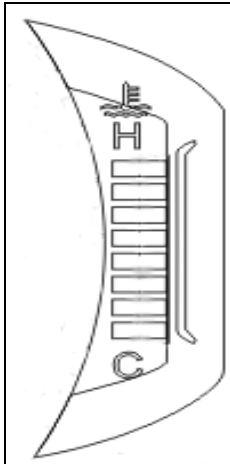

When the power is in “ON” position, this gauge indicates the temperature of the engine coolant. The working temperature of engine changes with the weather and engine load.



The coolant temperature icon turns into red and the right info display shows “coolant temperature is too high”, the engine coolant temperature is too high. If the car is overheated, please stop the car and let the engine cool down.

Under the following working conditions, the engine may become too hot:

- Climbing for long in hot weather.
- Driving with frequent stopping or idling the engine for long with the air conditioning system turned on.
- Towing a trailer.

Warning

Stop the car immediately if the engine water temperature is too high.

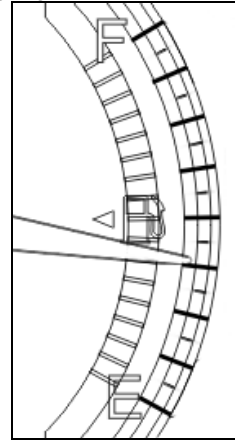

● Fuel gauge

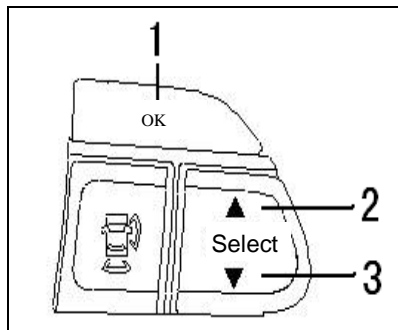

If the fuel level is too low (near “E”), the fuel level icon is illuminated, and the right info display shows “Please add fuel”, then, please add fuel as soon as possible.

- **Adjustment menu**
Enter and adjust the menu with steering wheel key.



1. OK is used to confirm the selection.
2.  is used to scroll up the menu selection bar.
3.  is used to scroll down the menu selection bar.

The menu structure is shown below:

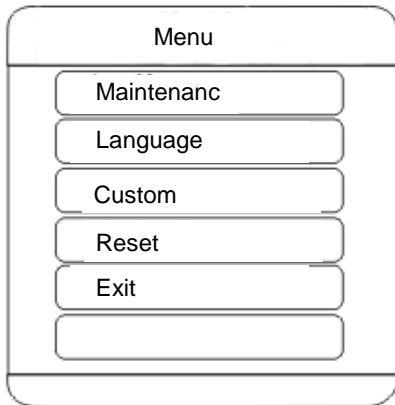

- **Maintenance**
 - Maintenance time
 - Maintenance mileage
 - View
- **Language**
 - Simplified Chinese
 - English
- **Custom**
 - Automatic door lock
 - Speed alarm
 - Theme

- Automatic rearview mirror mode
- Tire pressure unit (optional)

- **Reset**

The menu function is shown below:

1. Maintenance: set up the maintenance function and state
When the maintenance function is turned on, if the maintenance almost expires or has already expired, and the power is in "ON" position, the right info display will show corresponding prompt.

- 1) Maintenance time: set up the maintenance time

Item	Function
Maintenance time	Menu name
XX day Or ---	Currently set maintenance time, or display three short lines if this function is turned off



ON/OFF	Turn on/off maintenance time
+30 days	Increase the maintenance time by 30 days
-30 days	Decrease the maintenance time by 30 days
Reset	Reset the maintenance time
Back	Exit and back to previous menu

2) Maintenance mileage: set up the maintenance mileage

Item	Function
Maintenance mileage	Menu name
XX km or ---	Currently set maintenance mileage, or display three short lines if this

	function is turned off
ON/OFF	Turn on/off maintenance mileage
+500km	Increase the maintenance mileage by 500km
-500km	Decrease the maintenance mileage by 500km
Reset	Reset the maintenance mileage
Back	Exit and back to previous menu

3) View: view currently remaining maintenance time and mileage
 2. Language: set up the display language.

Item	Function
Language	Menu name

Simplified Chinese or English	Display currently set language
Simplified Chinese	Set the language to simplified Chinese
English	Set the language to English
Back	Exit and back to previous menu

3. Custom: customize the settings
 1) Automatic door lock
 Turn on/off the function: when the speed reaches 20km/h, the system will lock all doors automatically

Item	Function
Automatic door lock	Menu name
ON/OFF	Indicate current state of the function
ON	Turn on the automatic door lock
OFF	Turn off the



	automatic door lock
Back	Exit and back to previous menu

2) Speed alarm: set up the speed alarm

When the speed reaches set alarm value, the LCD in the right of the instrument will show the alarm info.

Item	Function
Speed alarm	Menu name
X km/h Or---	Currently set alarm speed, or display three short lines if this function is turned off
ON/OFF	Turn on/off speed alarm
+10km/h	Increase the alarm speed by 10 km/h
-10km/h	Decrease the alarm speed by 10 km/h
Back	Exit and back to

	previous menu
--	---------------

3) Theme Set up the theme of left and right LCD.

Item	Function
Theme	Menu name
Phantom or blue stars	Display currently set theme
Phantom	Set the theme to Phantom
Blue stars	Set the theme to Blue stars
Back	Exit and back to previous menu

4) Automatic rearview mirror mode (optional) Turn on/off the function: the rearview mirrors are folded automatically when the car is locked.

Item	Function
------	----------

Automatic rearview mirror mode	Menu name
ON/OFF	Indicate current state of the function
ON	Turn on automatic rearview mirror folding
OFF	Turn off automatic rearview mirror folding
Back	Exit and back to previous menu

5) Tire pressure unit (optional) Set up the tire pressure unit.

Item	Function
Tire pressure unit	Menu name
kPa, bar or psi	Currently set tire pressure unit















kPa	Set the tire pressure unit to kPa
bar	Set the tire pressure unit to bar
psi	Set the tire pressure unit to psi
Back	Exit and back to previous menu

5. Reset

Item	Function
Reset	Menu name
OK	Reset the menu settings to default
Back	Exit and back to previous menu

**Maintenance Prompt Indicators and Alarm Buzzer**

If the indicator is illuminated or the right info display has message display or buzzer sounds		Countermeasures
1		Parking brake fault warning light Possible situations: brake fluid level is low, braking system fault, parking brake isn't released Please stop the car immediately and contact BYD authorized service station.
2		Driver's seat belt indicator The driver should fasten the seat belt
3		Charging system warning light Please stop the car immediately and contact BYD authorized service station.
4		Engine oil pressure low warning light Please stop the car immediately and contact BYD authorized service station.
5		Engine fault warning light Send the car to BYD authorized service station for inspection.
6		Intelligence key system warning light
7		ABS system fault warning light Send the car to BYD authorized service station for inspection. If the warning light of parking brake fault is also illuminated, please stop the car immediately and contact BYD authorized service station.

8		Electrical control system fault warning light Send the car to BYD authorized service station for inspection.
9		Door state indicator Check and make sure that all doors have been closed.
10		Airbag fault warning light Send the car to BYD authorized service station for inspection.
11		Headlight adjustment indicator If this indicator is illuminated, please send the car to BYD authorized service station for inspection.
12		Tire pressure fault warning light (optional) If this indicator is illuminated or flashes, please send the car to BYD authorized service station for inspection.
13		Body stability control system fault warning light (optional) If this indicator is illuminated, please send the car to BYD authorized service station for inspection. If this indicator flashes, the body stability control system works normally.



Automatic air conditioner panel

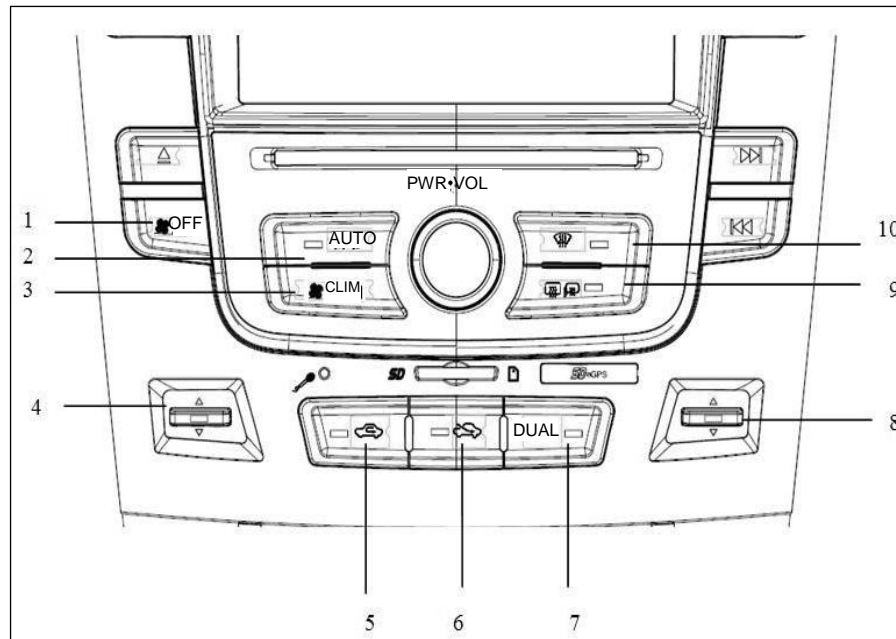

1. Air conditioner switch button
2. Automatic air conditioner button
3. Manual air conditioner button
4. Left air control temperature control switch
5. Internal circulation button
6. External circulation button
7. Sub-control button
8. Right air control temperature control switch
9. Rear window and exterior rearview mirror defogging button
10. Front defroster button

Multimedia system (optional)

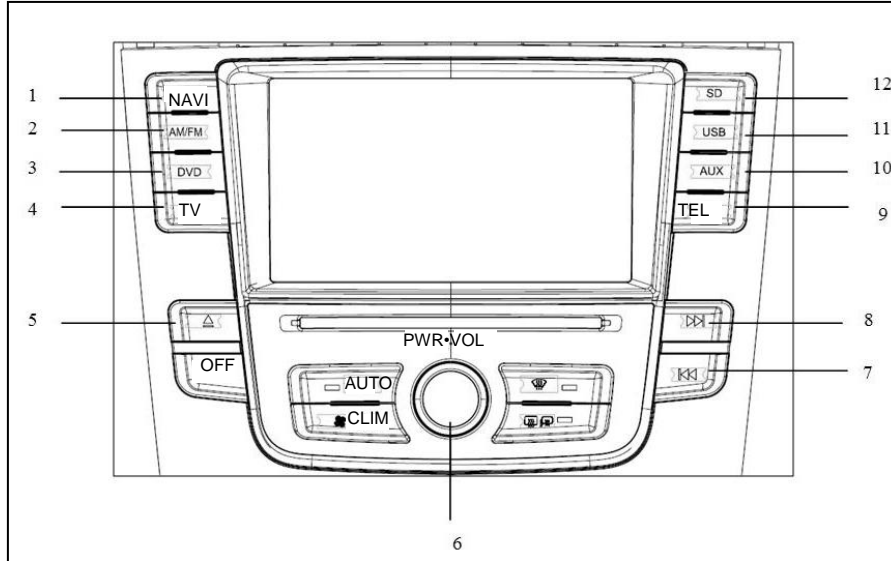

1. Navigation button
2. AM\FM button
3. DVD button
4. TV button
5. Eject button
6. Power/switch/volume knob
7. Previous button
8. Next button
9. Telephone button
10. AUX mode
11. USB mode
12. SD mode



Parking assistant module (optional)

Friendly Tips

- Before the engine is started, do not play the audio for too long time to avoid battery power loss.
- The inner and outer edges of new laser discs may be rough; before using, please remove the burr on the edge, or else the plastic debris on the rough edge may damage the movement.
- Do not insert any foreign matter into the CD player.
- Please use genuine discs with standard size, while pirated discs may be stuck in the movement.
- USB equipment prompt: 1) it is recommended that use the provided data cable to connect the USB disk. 2) USB interface doesn't support removable hard disk. 3) USB interface only supports MP3, WMA music files and MP4, 3GP, AVI video files of

FAT file system. 4) USB interface may not support the USB storage devices with poor compatibility.

- If there is any abnormal condition, such as smoke and odor, immediately turn it off, and contact BYD authorized service station; do not repair without permission.

The parking assistant sensor uses the sensor in the front and rear of the car to detect the distance between the car and obstacles, and inform the driver about this distance through indicator, touch screen and buzzer alarm.

Parking assistant switch

The parking assistant switch is located on the center console.

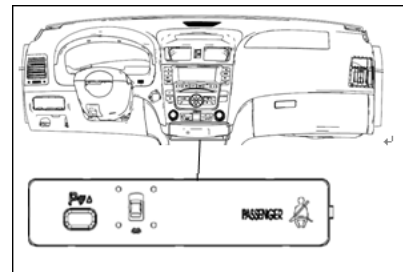

Turning on: press the switch .

The indicator  on switches group display is illuminated and the buzzer rings once, and the system will work under the following conditions:

For DCT models, if the shift lever isn't in P position, the front side sensor works; if the shift lever is in R position, all sensors work.

Turning off: press this switch again.

Icon display on the touch screen (optional)

When the screen shows the image of obstacle, the upper right of the screen

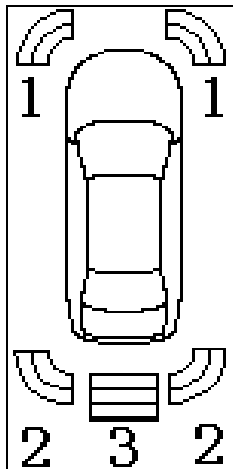

shows the reversing radar alarm icon in real time.





Distance display and buzzer alarm



When the sensor detects obstacle, it will display the direction of the obstacle and the distance from the car; at the same time, the buzzer rings and the corresponding indicator flashes at the same frequency.

Working example of front side sensor



Approximate distance (mm)	Display example	Alarm sound
600~500		Fast
≤500		Long

Working example of rear side sensor

Approximate distance (mm)	Display example	Alarm sound
1200~800		Slow
800~500		Fast

600~500		Fast
≤500		Long

Working example of front center sensor

Approximate distance (mm)	Display example	Alarm sound
1200~800		Slow
800~500		Fast

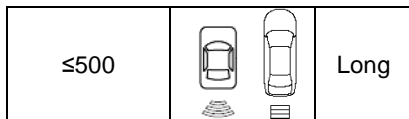

Sensor detecting range

When the car is reversing, all sensors work.

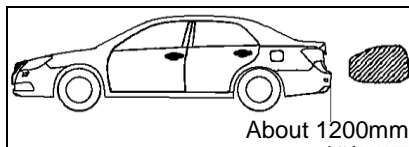
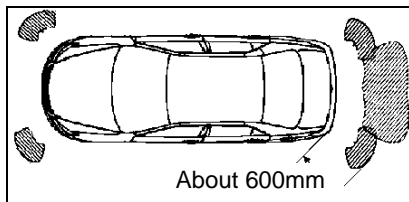

The figure shows the detecting range of the sensor. Above range is limited, check the surrounding environment first and then back slowly.

Sensor detecting info

Certain car state and surroundings may affect the sensor in detecting obstacles.

The specific conditions that may have impacts are listed below:

- There is dirt, water, or mist on the sensor;
- The sensor has snow on it or is frozen;
- The sensor is covered in any way;
- The car rolls over or is overloaded;
- In particularly bumpy roads, slopes, gravel pavement or grass;
- The sensor is re-sprayed;
- Due to vehicle horn, engine sound of motorcycle, air brake sound of large vehicles, or any other noises that will cause ultrasonic, the car surrounding is very noisy;
- There is another vehicle equipped with parking assistant system nearby;
- The car is installed with traction ring;
- The bumper or the sensor has

been strongly impacted;

- The car is approaching to a higher or zigzag road edge;
- In the burning sun or cold weather;
- Installation is non-original and is lower than the original suspension.

In addition to the above situation, the sensor may not be able to correctly determine the actual distance due to the shapes of some objects. The shape and material of the obstacle may impede the detection of the sensor. Pay particular attention to the following obstacles.

- Wires, fences, ropes, etc.;
- Cotton, snow and other materials that absorb radio waves;
- Objects that have sharp edges and corners;
- Low obstacles;
- The obstacles that the upper part stretching outward toward the car;
- Objects under the bumper;
- Objects near the vehicle;
- The staff that near the car

(according to the clothing).

If the combination instrument has image display or buzzer sounds, it is possible that the sensor detects an obstacle, or the outside interferes with the sensor.

If this situation persists, contact BYD authorized service station for repair.

Parking imaging system (optional)

The parking imaging system help the driver park by displaying rear or right front road condition in real time, which is an auxiliary means of parking.

When the start button is set to "ON",

press the  key on the steering wheel to start the right front imaging

mode; press  again to turn off the right front imaging mode; when the start button is set to "ON", turn the shift lever to "R" position to turn on the reversing imaging mode; press the

 key on the steering wheel to switch between reversing imaging mode and right front imaging mode.

The right front camera is installed on the right rearview mirror; the reversing camera is installed on the back door.

Parking operation

Enable parking imaging system when the vehicle needs parking. If reversing isn't required, directly enable the right front imaging mode. Through direct observation of the surrounding environment and the use of imaging system, approach the car slowly to the parking location.

While reversing, press the  button to switch between reversing imaging and right front imaging to observe in real-time the places that can't be seen and help parking.

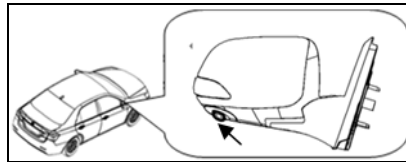

Right front camera mounted on the right rearview mirrors

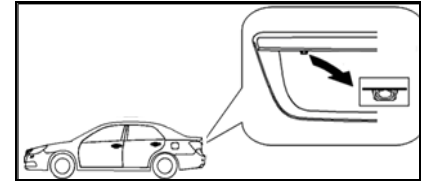

Reversing camera mounted on the back door

Limitations of parking imaging system

The camera's field of view is limited. The objects close to both sides of the bumper or below the bumper can't be seen on the reversing imaging screen; the objects in front, right center and rear side of the bumper can't be seen on the right front imaging. As shown below:

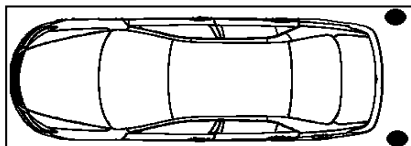

Objects close to the bumper corner

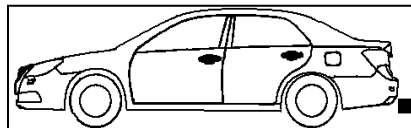

Objects located below the bumper

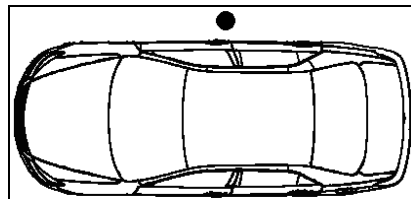

Objects in the center of the car

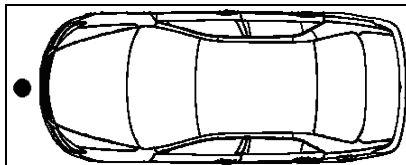

Objects in the front

The display area varies with the direction of the car and road condition. This system can only play an auxiliary parking role.

Before using the reversing imaging system, make sure that the space is sufficient.

Display example on the touch screen



Right front imaging screen



Reversing imaging screen

The two lines in the figure are safety lines of reversing.

Red: 0-0.5m

Yellow: 0.5-2m

Green: >2m

Cigarette lighter note

Do not press and hold the cigarette lighter.

Fatigue warning system (optional)

Driver fatigue warning system uses a camera to collect driver's face image signal in real-time and send the image signal to the real-time image processing unit, which will inform the driver in audible alarm if it detects

driver in fatigue state.

The system mainly uses image processing, pattern recognition technologies, driver fatigue gradient model, and combines driver's head position change, eyes closing characteristics and other factors to perform a comprehensive judgment on driver fatigue.

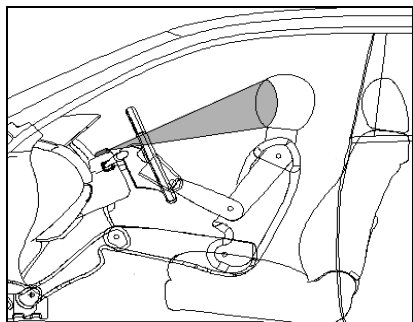

Fatigue warning system

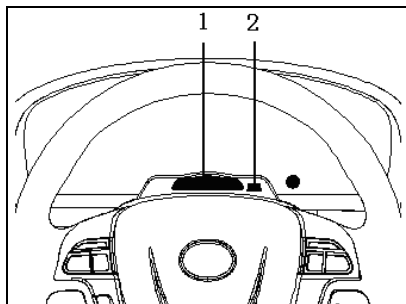

1. Camera module

2. Function key

Usage

After system power on, it automatically identifies the current safe driving speed, and starts collecting human face and other information if the speed exceeds this value; the minimum safe speed is about 50km/h.

After the car has run for some time, the fatigue warning system detects the driver enters fatigue state from

awake, and prompts “Don't drive when tired” in voice.

The system enters the monitoring mode, and starts collecting the human face and other information when the speed exceeds 50km/h.

- **Turning on**

If the system is turned off, press the function key, and the voice prompts that “fatigue warning system is turned on”.

- **Turning off**

If the system is turned on, press the function key, and the voice prompts that “fatigue warning system has been closed”.



Camera info

● Use of the driver fatigue warning and monitoring module camera

In order to ensure that the driver fatigue warning and monitoring module plays the role, please observe the following matters. If not, it may malfunction, causing failure of determination of face orientation/eye opening and closing.

- Do not modify, damage, pick up, or pull the camera;
- Do not touch the camera while driving;
- Do not wet the camera or sprinkle drinking water on the camera;
- Do not let items fall off and hit the camera;
- Ensure that the camera surface doesn't have scratch, dirt, dew, or label;
- Do not place objects in front of the camera or cover the camera.

Special Note

The following situations may cause determination failure of the system; never drive when tired.

- **Face and eyes are covered (sunglasses, black-rimmed glasses, masks, false eyelashes, fringe is too long, etc.).**
- **Direct exposure to the sun or lighting of the face or camera.**
- **Not drive in correct posture.**
- **Eyes are too small or frequently blink.**
- **Too high or too short.**
- **Other external factors that may interfere with the system determination.**

Determination of face orientation and eyes opening/closing

The system has certain requirements on driver sitting posture and face orientation.

- Sit upright.
- Face forward, without excessive

tilt and pitch.

If the alarm conditions are reached but the multimedia doesn't have corresponding voice prompts, please check whether the camera monitoring module works normally and whether is the result of the above reasons.

Tire pressure monitoring system (optional)

I. System description

Tire pressure monitoring system: Installed on the car, it is an auxiliary system that can monitor the tire pressure and other parameters in real-time, and display and alarm in visual and auditory signals, in order to improve the driving safety and comfort of the car, and reduce accelerated tire wear and energy consumption increase due to insufficient air pressure.

The system consists of tire pressure monitoring module, tire pressure monitoring and control module and display part. Tire pressure monitoring



module is installed on the tire valve of the radial tire (vacuum tire), tire pressure monitoring and control module is installed in the compartment, and the display part is realized by the meter.

The standard pressure of front wheels of F7 is 240Kpa (2.4Bar, 34.8Psi), and the standard cold pressure of the rear wheels is 230Kpa (2.3Bar 33.4Psi).

This system has the following characteristics:

- ① Humanized design, human-machine interface; display on meter LCD screen, which is reliable, beautiful, practical, and simple
- ② Alarms of high tire pressure, low tire pressure, and fast leaking
- ③ Display the pressure values of the four tires
- ④ Monitor changes of tire pressure value in real-time

II. Basic functions

1) Boot alarm

Tires are under low pressure state when the power of the car is cut off; when the power resumes, alarm low pressure immediately to prompt to inflate the tire before driving.

2) Low tire pressure alarm

When the tire pressure is lower than 75% of the standard tire pressure (front tire pressure is lower than 180KPa/1.8Bar/26.1Psi, rear tire pressure is lower than 172Kpa/1.72Bar/24.9Psi), and the system is running, TPMS will send low tire pressure alarm signal in 6 seconds, and indicate the location of the low pressure tires.

After low pressure alarm, inflate the tire to standard pressure; when the tire pressure is greater than 90% of the standard pressure, the low pressure alarm cancels.

3) High tire pressure alarm

When the tire pressure higher than 130% of the standard tire pressure (front tire pressure higher than 312Kpa/3.12Bar/45.3 Psi, and rear tire pressure is higher than 299Kpa/2.99Bar/43.3Psi), and the system is running, TPMS will send high tire pressure alarm signal in 6 seconds, and indicate the location of the high pressure tires.

After driving a long period of time, the tire pressure slightly increases due to the increase of the temperature (cars generally not higher than 30Kpa); this is a normal phenomenon and users do not have to worry about the tire situation.

Friendly Tips

When the system function is enabled, and the speed is 0-50 km/h (kilometer/hour), the alarm cancels.

If the car has started overpressure



alarm, continue driving until the tire temperature or tire pressure reduces.

4) Fast leaking alarm

When one or more tires leak and the rate is greater than or equal to 30Kpa/min, and the system is running, TPMS will send fast leaking alarm signal within 1min, and indicate the location of the flat tires.

If the car has started leaking alarm, please stop and check failure tire immediately, and make sure that the tires do not have failure before driving.

5) Abnormal signal alarm

When the system is running, the system tests automatically and sends alarm signal in 10 minutes if any failure is detected.

6) Real-time display of tire pressure value

In running condition, TPMS displays

the pressure value of each tire.

III. Alarm display description

Tire pressure fault warning light is:



Alarm content	Display mode	Recommended operation
Tire pressure is too low	① Tire pressure fault light is lit ② Tire pressure value becomes yellow	Please check the appropriate tires for the slow leaking, and inflate the air pressure to a reasonable range
Tire pressure is too high	① Tire pressure fault light is lit ② Tire pressure value	Please check the appropriate tires for the high pressure, and inflate

	becomes yellow	the air pressure to a reasonable range
Fast leaking	① Tire pressure fault light flashes ② Tire pressure value becomes red	Please check the appropriate tires for the leaking
Abnormal signal	① Tire pressure fault light flashes and is lit ② Tire pressure value displays abnormal signal	Please check whether the tire monitoring module is normal, and whether in large electric field for a long time



System failure	<p>① Tire pressure fault light flashes and is lit</p> <p>② Text prompt: please check the tire pressure monitoring system</p> <p>③ Tire pressure value displays abnormal signal</p>	<p>Please check whether the tire monitoring module and the tire pressure control module are normal, and replace the tire monitoring module or tire pressure control module</p>
----------------	--	--

IV. Precautions

- 1) The usage time of tire pressure monitoring module depends on daily driving distance and similar factors.
- 2) If the tire pressure is abnormal, this system won't stop the running of the car; therefore, every time before driving, the user should check whether the tire pressure complies with the tire pressure specified by the manufacturer in static state. Do not drive the car if the tire pressure is abnormal, or else it will damage the car or cause body hurt. If there is abnormal condition, please check the tire pressure immediately.
- 3) The tire monitoring module sends tire pressure info to the monitor regularly; therefore, if the tire pressure drops suddenly while driving or the tire is blown up, the monitoring module only can send the data to the monitor next time, and thus the driving may be out of control. If the monitoring module is also damaged when the tire is damaged and thus can't send message, or if you suspect that certain tire is damaged, please stop driving immediately instead of waiting for the monitor to send alarm signal.
- 4) If the tire pressure monitoring module isn't installed properly, it will affect the air tightness of the tire. Please ask the qualified personnel of BYD authorized distributor/service station to install and replace the monitoring module according to the installation instructions.
- 5) If the tire position should be changed or tire pressure monitoring module should be replaced, the entire tire pressure monitoring system should be re-matched. Please ask the qualified personnel of BYD authorized distributor/service station for re-matching, or else it will cause invalid of the system.



Constant speed cruise control

The constant speed cruise control allows keeping at the preset speed higher than 40km/h without stepping on the acceleration pedal. This function can be enabled when driving on straight and smooth expressway.

Enabling constant speed cruise control

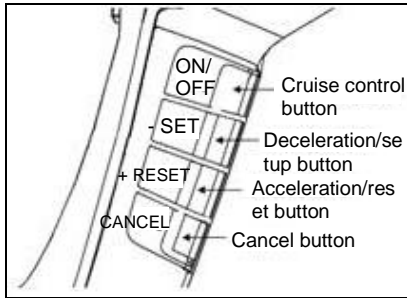

1. Press the constant speed cruise control (ON/OFF) button in the right of the steering wheel, and the constant speed cruise control indicator on the instrument panel

will be lit.

2. Accelerate the speed to higher than 40km/h.
3. Press the “SET/-” button to enable constant speed cruise control.
4. During upgrade/downgrade driving, the constant speed cruise control can't maintain the preset speed.

Changing preset speed

The cruise speed can be increased in any of the methods below:

1. Press and hold “RESET/+” button (more than 0.5s), and the car will speed up continuously. When reaching desired cruise speed, release the button.
2. Step on the accelerating pedal. After reaching desired cruise speed, press the “SET/-” button.
3. To increase the speed slightly, press the “RESET/+” button

repeatedly. The car speed increases by 1.6km/h every time, and will increase to 165km/h at most.

The cruise speed can be decreased in any of the methods below:

1. Press and hold the “SET/-” button to reduce the speed. Release the button after reaching desired speed. If the speed is reduced to 40km/h, the system will cancel cruise control.
2. Step on the brake pedal lightly; when the car decelerates to desired speed (> 40km/h), press the “SET/-” button, and the car maintains the desired speed.
3. To reduce the speed slightly, press the “SET/-” button repeatedly. The car speed decreases by 1.6km/h every time, and the system will cancel cruise control when the speed is reduced to 40km/h.

Canceling constant speed cruise control

The constant speed cruise control can be canceled in any of the methods below:

1. Step on the brake pedal.
2. Press the CANCEL button on the steering wheel.
3. Press the constant speed cruise control (ON/OFF) button.
4. Move the gear position to D.

DCT Transmission Control Panel

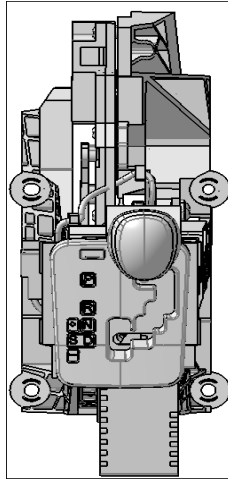

Gear position indicator is located in the lower left side of the tachometer, and displays currently selected mode and gear position of the automatic transmission:

P: park

R: reverse

N: neutral

D: drive (economic mode)

S: sport mode

M: manual mode

Position of shift lever

The position of shift lever includes park, reverse, neutral, drive, sport and manual.

Park (P) — in this position, the transmission and shift lever are locked in mechanical mode. The gear should be in this position when the engine is shut down or started. To shift away from parking position, the ignition switch should be in ON position, and step on the brake pedal to shift away from this position.

Note: When shifting to park position, wait for the car to stop completely to avoid transmission damage.

Reverse (R) — for the operation of shifting from park position to reverse position, please refer to the **Note** of Park (P).

Neutral (N) — to restart the flameout engine, or let the engine run idle to



stop the car temporarily, use the neutral position. No matter for what reason, it is required to shift to park position if you get off the car. In this position, the shift lever will be locked.

Drive (D) — use this position during normal driving. The transmission will select appropriate position automatically according to the car speed and acceleration. In this position, the car is in economic mode, and consumes the least fuel.

Sport (S) — in sport mode, the dynamics of the car is higher than in economic mode.

Manual (M) — in manual mode, you can push the shift lever to upshift (+) position or downshift (-) position, so as to control the gear position of manual transmission.

Upshift (+) — during normal driving and the shift lever is in manual mode, push the shift lever to this position, the transmission control unit (TCU) will determine according to current car

speed, and the transmission position will upshift accordingly until the top position (six).

Downshift (-) — during normal driving and the shift lever is in manual mode, push the shift lever to this position, the transmission control unit (TCU) will determine according to current car speed, and the transmission position will downshift accordingly until the bottom position (one).

Selecting sport mode

When the shift lever is in D position, push the lever to the left without upshifting/downshifting, and the sport mode is selected. The gear position display of the combination instrument displays D1, D2, D3, D4, D5, and D6.

Selecting manual mode

When the shift lever is in D position, push the lever to the left, then push the shift lever forward or backward, the manual mode is selected, and the gear position display of the

combination instrument displays M1, M2, M3, M4, M5, and M6.

Note:

1. The shift lever is in the same position in sport mode and manual mode;
2. To shift from M position to S position again, shift the lever to D position first, and then shift to S position.
3. In sport mode, the first upshifting/downshifting operation is the switching signal to enter manual by default; the transmission won't perform corresponding operation.

Starting the car

To start the engine, the shift lever must be in park (P) or neutral (N) position.

Stopping

To stop the car, please first release the accelerator pedal and step on the brake pedal, take up the hand brake when the car stops completely and finally shift the lever to P position.

**Note:**

- ◆ When parking on a ramp, be sure to step on the brake pedal and take up the hand brake. Do not stop the car from slipping by stepping on the throttle pedal in drive position, which may lead to overheating of the transmission clutch or badly worn.
- ◆ For parking, before shifting the lever to P position, make sure to take up the hand brake first. When the car is parked on the ramp, the car may move downwards slightly when the brake pedal is released. Before shifting the transmission to park position, take up the hand brake to avoid applying pressure on the parking mechanism in the transmission when the car moves, so that the lever can shift from the park position easily when you want to drive the car.

Ramp start

To protect the DCT transmission, please use the hand brake to assist the start on steep ramp.

Special environment

In case of downhill, bend, or mountain road, we recommend using the manual mode, and shift to lower position in order to take full advantage of engine braking.

minutes, and drive when the transmission cools down.

Friendly Tips

- ◆ If the car is frequently started or drives at "low speed", or start and stop with the traffic for a long time, it may result in overheating of the DCT transmission clutch.
If the clutch of DCT transmission is overheated, the instrument will display the alarm. In this case, the transmission control module will disconnect the clutch to protect it from damage, causing the car can not drive. If such phenomenon occurs, step on the brake pedal to stop a few





Chapter 2

Driving Tips

Notice for Running-in Period.....	2-1
Fuel.....	2-2
Engine Hood.....	2-3
Gasoline Detergent	2-4
Checking Engine Oil.....	2-4
Checking Engine Coolant.....	2-5



Notice for running-in period

In the first 1,000km, pay special attention to the driving mode to ensure the reliable performance of the car. Note the following in this period:

1. Avoid full throttle in starting and driving.
2. Avoid emergency braking in the first 300km.
3. Do not replace the engine oil before reaching the time or mileage recommended in the regular maintenance table.

Also follow above notice after overhaul, or replacing the engine or friction plate.

Fuel

1. 483QB engine and 476ZQA engine can use octane rating 93 or higher grade unleaded gasoline.
2. Using leaded gasoline will damage the emission control device and engine of the car, and also will aggravate air pollution.

3. Using low grade or low-quality gasoline will reduce engine life.
4. For 476ZQA turbocharged engine, it is recommended that use higher quality fuel.

Adding fuel

Filler cap is located on the left side of the car. Please keep this side near the pump in the gas station.

1. Press the handle outside of the driver's seat to open the filler cap.
2. Slowly remove the fuel filler cap. Due to the release of pressure within the tank, you may hear a hiss. Filler cap is connected to the refueling funnel with the chain, to prevent losing the fuel filler cap. For refueling, mount the filler cap on the bracket of the filler cap.

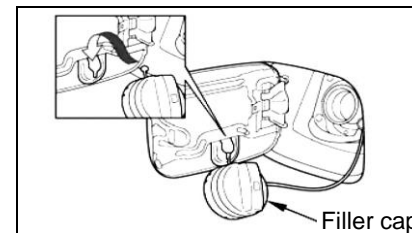
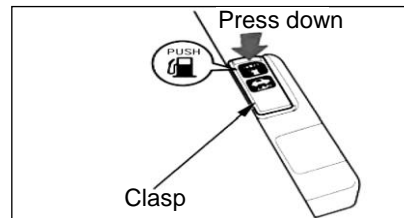

3. When the refueling gun automatically cuts off, stop refueling. Do not fill the tank too full, in order to leave space for fuel expansion in case of temperature change.
4. Screw the fuel filler cap back into place and tighten until you hear at least twice clicking sounds.

5. Push and lock the fuel filler cap.

Friendly Tips

When refueling, note the following points:

- Gasoline is easily flammable. When refueling, shut down the engine, stay away from heat source, sparks and open flames, and do not smoke. Open flame is easy to cause a fire.
- When opening the fuel tank cap, do not immediately remove the cap. In hot weather, if the fuel tank cap is removed suddenly, the fuel under pressure will eject from the filler and cause personal injury.
- It is recommended that refuel outdoor and immediately wipe away spilled fuel.
- Do not overfill the fuel, which helps reduce fuel consumption and improve the life of activated carbon canister;
- Please go to a regular gas station for refueling; counterfeit and shoddy fuel will make your engine jitter and

have weak speed up and other faults.

Engine hood

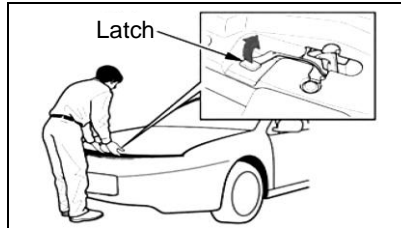
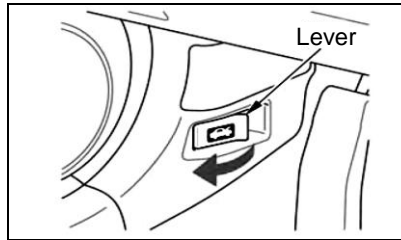

1. Shift to park or neutral position, and pull up the hand brake. Pull up the engine hood opening handle located in the lower left corner of the instrument panel,

and the engine hood will bounce a little.

2. Stand in front of the car. In the middle-right location, reach the fingers into the leading edge of the engine hood, and then move the fingers to the left and you will touch the hood latch. Push up the lock, and lift the engine hood after the engine hood is released.
3. Lift the engine hood, the hydraulic strut will raise it to the highest level and hold the engine hood.

To close the engine hood, lower to a height about 30cm above the grille and firmly push down with both hands. When the engine hood is closed, check whether the lock is locked securely.

If you do not have to toggle the hood latch to open the engine hood, or hood latch does not move freely or can not rebound back, please contact BYD authorized service station for inspection and repair.

Friendly Tips

Before driving, make sure that the engine hood is closed and locked. Otherwise, the engine hood may suddenly open during driving and cause an accident.

Gasoline detergent

1. Gasoline detergent can effectively remove carbon deposits, sludge and other sediments of the engine fuel system.
2. For turbocharged and direct injection engines, the gasoline detergent must be applied according to requirements properly on a regular basis and in sufficient quantities. For naturally aspirated engines, the gasoline detergent can also be applied reasonably based on the maintenance cycle and condition of the engine.
3. BYD authorized service station

provides proven “BYD dedicated gasoline detergent”.

4. Not all gasoline detergents are valid. The use of inappropriate gasoline detergent may cause engine damage. BYD approved gasoline detergent is recommended.

Checking engine oil

It is normal that the engine consumes engine oil. The actual engine oil consumption depends on your driving and running conditions of the car.

Therefore, the oil level must be checked regularly. It is best to check the liquid level every time when refueling or before long-distance traveling, and refill if necessary.

1. Take out the oil level gauge.

The upper and lower limits of the engine oil level gauge are two convex lines, which are labeled as "F" and "L"; the oil level should be located between the upper and lower limits.

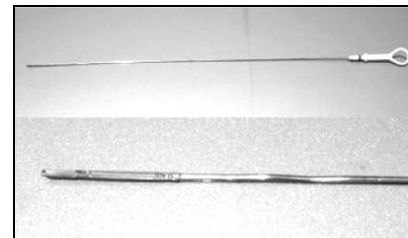

2. Wipe the oil level gauge with a clean cloth or paper towel.
3. Insert the oil level gauge back to the sleeve.
4. Take out the oil level gauge again, and check the oil level. The oil level must be between the upper and lower limits.

Checking engine coolant

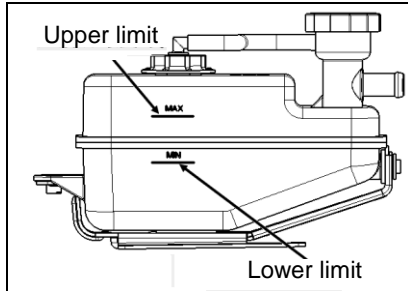

View coolant level in the radiator tank. Confirm whether it is between scale lines of the upper limit (MAX) and the lower limit (MIN).

Fuel-saving tips (driving habits)

Smooth driving helps save fuel. Acceleration, sharp turns and emergency brakes will consume more fuel.

Try to keep driving in top position to ensure smoother engine operation and acceleration.

According to traffic conditions, try to keep at constant speed. Each

deceleration or acceleration of the car will increase fuel consumption. In the appropriate driving conditions, using constant speed cruise control (optional) will save more fuel. Cold state engine consumes more oil than thermal state, but there is no need for warm-up and let it idle for a long period of time. No matter how cold outdoor, the car can be driven away in one minute after the engine is started. In this way, the engine will heat up faster, thus saving fuel. Try to arrange shorter mileages together, in order to reduce the times of "cold state start". Turning on the air conditioner will increase the engine load, which consumes more fuel. Turning off the air conditioner can reduce fuel consumption. When the atmospheric temperature is suitable, outdoor circulation pattern should be used.

Carrying luggage

The car is equipped with a number of

convenient storage locations, which can be used to carry the luggage safely.

The right glove box, door paper bags and seat back paper bags are designed for storing small pieces and lightweight items, while the luggage compartment is used for storage of larger and heavier items.

In addition, the luggage compartment channel opening allows you to carry long items in the car.

However, the handling, stability and normal running of the car may be affected and the safety is reduced if carrying too much luggage or loading improperly.

Load limit

When loading luggage, the total mass of the car body, all passengers and luggage must not exceed the maximum allowable mass.

Warning

- **Overloading and improper**



loading will affect vehicle handling and stability, and may lead to the crash and casualties.

- **Please follow the load limit and other load criteria in this manual.**

Carrying objects in passenger area

1. Properly put or fix all objects that may be thrown to the car and hurt the passenger in case of car crash;
2. Do not keep any object on the rear window board. Otherwise, these objects will restrict your sight, and will be thrown everywhere in the car crash;
3. To ensure that the objects placed on the rear floor of the front seat won't roll under the seat, thus affecting the regulation of driver control pedal or seat. Do not push the goods beyond the front seatbacks;
4. While driving, ensure that the glove box has been closed. If the

glove box lid is open, the knees of the passenger may be hurt in a crash or emergency stop.

Carrying luggage in the luggage compartment

1. Put the luggage evenly on the floor in the luggage compartment, and put the heaviest luggage on the bottom and as front as possible;
2. Fix the objects with a rope or chain to prevent it from moving when you are driving. Do not make the stacked objects higher than the seat backs of the front seats;
3. If the bulky objects impede you close the luggage box cover, the discharged exhaust gas will enter the passenger area.

About various matters relating to the bundled products and fixtures on the market, please contact BYD service station.

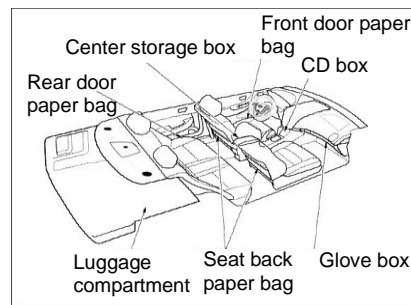



Chapter 3

Starting and Driving

Before Starting the Engine.....	3-2
Engine Starting Method.....	3-2
Safety Examinations before Driving.....	3-2
Notice for Gear Shift.....	3-4
Driving Tips under Different Conditions.....	3-4
Driving Tips in Winter.....	3-5
Trailer Towing.....	3-6
Parking Brake.....	3-7
Special Situation Treatment while Driving.....	3-8



Before starting the engine

1. Before entering into the vehicle, check the surrounding environment.
2. Adjust the seat position, height and backset angle, the height of head protection device and the angle of steering wheel.
3. Adjust the interior and exterior rearview mirrors.
4. Lock all the doors.
5. Fasten the seat belt.

Engine starting method

1. Before starting

- 1) Pull down the parking brake.
- 2) Turn off all unnecessary lights and auxiliary devices.
- 3) For manual transmission: set the shift lever to neutral position; if not, step down the clutch pedal to the bottom until the engine is started, and switch the transmission to neutral (the car can be started by pressing the clutch or the brake,

however, the latter isn't recommended)

- 4) DCT transmission: make sure that the shift lever is in parking (P) or neutral (N) position, and step down the brake pedal.
- 5) The anti-theft system releases the security state.

2. Engine starting

Before starting the engine, make sure the work described in "Before starting" has been done.

Normal starting

The multi-point fuel injection system in the engine will automatically control the mixture of air and fuel used for starting. You can perform cold or warm engine start according to the following procedures. Move the start button to "ON" position to start the engine. Then engine can warm up by driving rather than by running idle. Steadily run the engine to warm up the driving vehicle until the temperature of the

engine coolant rises to the normal range.

Friendly Tips

Reduce the idle time in case of cold start of 476ZQA.

If the engine stalls

Start it again according to the normal starting procedures.

Safety examinations before driving

Before driving, it's best to examine the vehicle carefully, or ask a BYD authorized service station to examine it for you. It takes only few minutes but will bring you driving safety and enjoyment.

Friendly Tips

If the examination is done in a closed garage, make sure the garage is well ventilated. The engine exhaust is poisonous.

Examinations before starting the



engine

Vehicle exterior

Tires: Determine the tire pressure with a tire pressure gauge and check carefully whether there is any cut, damage or over wear.

Wheel bolts: Make sure the bolts are not loose or lost.

Leakage: After the vehicle has been parked for a while, check whether there is any fuel, engine oil, water or other liquid leakage on the ground. (It's normal that there are water drops produced by the air conditioning system.)

Lighting: Make sure head lights, parking lights, small lights, turn signal lights and other lighting devices can all work normally. Check the light intensity of the head lights.

Vehicle interior

Spare tire, jack and wheel bolt wrench: Check the tire pressure and make sure the vehicle is

provided with a jack and a wheel bolt wrench.

Seat belt: Check whether the buckle can be fastened firm. Make sure the seat belt is not worn or scraped.

Instruments and controllers: Specifically, make sure the maintenance indicators, instrument lighting and defrosters can work normally.

Brake: Make sure there is enough free clearance for the pedal.

Engine compartment interior

Spare fuses: Make sure spare fuses of different rated amperage are provided in the fuse box.

Coolant level: Make sure the coolant level is correct.

Battery and cable: Check whether the battery connectors are corroded or loose, whether the box has cracks and whether the cables are well connected.

Wires: Check whether there are broken, loosened or disconnected wires.

Fuel pipe: Check whether the pipeline has leakage or loose connection.

Friendly Tips

Do not put toys in the car; although it is convenient for children playing, it will leave security risks; especially in emergency braking or crash, the toys not only affect the driving safety, but also even hurt the children.

After the engine is started

Exhaust system: Check whether there is gas leakage by listening. If any, repair the exhaust system immediately.

Engine oil level: Stop the engine and park the vehicle on the flat ground. After a few minutes, determine the engine oil level with an oil measuring meter.

In driving

Instruments: Make sure the maintenance indicators and the speedometer work normally.



Brake: Check the brake in a safe place and make sure it doesn't deflect to any direction in braking.

Examination of other

abnormalities: Check to see whether there are loose parts and leakage; listen to see whether there are abnormal noises.

If all goes well, you can rest assured and enjoy the driving.

Notice for gear shift

- Under low temperature in winter, it may be difficult to shift before the engine oil warming up; this is normal instead of mechanical failure;
- In stopping state, it is difficult to shift to "1" position or "R" position; set the shift lever in neutral position, release, step on the clutch pedal and then shift;
- While driving, except shifting gear, do not put hand on the shift lever at other time, or else it will accelerate the wear of

transmission;

- When shifting from high position to low position, do not downshift two or more gear positions, or shift to low position when the engine is at high speed (5000Km/min), or else it will damage the engine.

Driving tips under different conditions

- When driving against the wind, you should drive slowly so that the vehicle can be controlled easily.
- Avoid driving on high and sharp objects or other road obstacles; otherwise, severe tire damages, e.g. explosion, may be caused.
- Reduce the speed when driving on uneven roads; otherwise, the impact will severely damage the tires and wheels.
- The brakes will be wetted in cleaning the vehicle or driving through deep water. You can

check whether they are wetted by pressing the brake pedal lightly. Before the check, you should first make sure it is safe. If you cannot feel the normal brake force, the brakes may have been wetted. To dry them, you can, with the parking brake used, drive carefully and lightly press the brake pedal.



Friendly Tips

- Before driving, make sure the parking brake is thoroughly released and the parking brake indicator is out.
- When the engine is working, do not leave the vehicle.
- Do not place your foot on the brake pedal in driving; it may lead to over-heat and wear of the brake and fuel waste.
- When going down a long steep slope, you should reduce the speed and turn to a low-speed gear. Frequent brake manipulation will lead to over-heat and, possibly, performance faults.
- Care should be taken in accelerating, high gear shift, low gear shift or

braking on slippery roads. Sudden acceleration or engine brake will lead to vehicle sliding or turning.

- Do not drive if the brakes are moistened. When the brakes are moistened, longer brake distances are needed, and, the vehicle may be hauled to one side when the brakes are used. Similarly, the parking brake cannot park the vehicle firm either.
- While driving, do not reach the head or hands out of the window, to avoid accidents and hazard, especially when children are in the car.

Driving tips in winter

Make sure the coolant has proper anti-freezing protection effect.

Only coolants specified by BYD authorized service stations can be

applied. You should select proper coolant according to the environment temperature and add it into the cooling system.

Application of unsuitable coolants will damage the engine cooling system.

Warning

- Do not use water in the cooling system, because the water may damage the cooling system

Check the battery and the cable.

Energy of all batteries can be reduced by cold whether, so the battery shall have sufficient power for starting in winter.

Make sure the engine oil viscosity is suitable for driving in winter.

For recommended engine oil viscosity, too much summer-use engine oil remaining in the engine will lead to starting difficulty in winter. If you are not sure which engine oil should be



used, you can seek help in any BYD authorized service station.
Protect door locks from being frozen by ice or snow.

Inject some deicer or glycerin into the door lock holes to prevent freezing.

Apply cleaning liquids containing anti-freezing agents.

Such products are available in BYD authorized service stations. The anti-freezing agent should be mixed with water according to instructions of the manufacturer.

Warning

Do not use the engine anti-freezing agent or other substitutes as the cleaning liquid, since it may damage the vehicle paint.

Do not use the parking brake if it may be frozen.

For parking, set the gear lever in the neutral gear and block up the

rear wheels. Avoid using the parking brake; otherwise, its periphery may be frozen by accumulated water or snow, causing it difficult to release.

Make sure there is no accumulated snow or ice under the dashboard.

Accumulated snow or ice under the dashboard may lead to turning difficulty. In freezing winter, you should stop often to see whether there is any accumulated ice or snow under the dashboard.

It is suggested you carry some necessary tools for emergent use according to the road conditions.

It's best you have a tire chain, a window scraper, a bag of sand or salt, a signal flashing device, a small shovel, connecting cables, etc. in the vehicle.

Trailer towing

BYD F7 is designed mainly for transporting passengers. Towing trailers will exert adverse influence on operation, performance, brake, durability and economical driving (fuel

consumption, etc.) Safety and comfort of driving are totally dependent on correct use of the instruments and a good driving habit. For your own and others' safety, do not overload the vehicle or use it to haul trailers. BYD won't take responsibilities for damage or faults caused by trailing with commercial purposes.

Weight limit

Before towing a trailer, the towing capacity of the trailer should be confirmed. You can contact a local BYD authorized service center and make sure that the towing capacity of the trailer is within the regulated range. The towing capacity is determined on a flat road surface. It should be remembered that in mountainous regions, the engine power and its towing capacity will be reduced.

Friendly Tips

The hauled trailer weight should not exceed the



maximum rated weight of the towing hook; otherwise, accidents and severe human damage may be caused. Towing may increase the brake distance, so in trailer towing, the safety distance should be lengthened. At a speed of 10km/h (kilometer/hour), the distance between your vehicle and the preceding vehicle should be at least the sum of the lengths of your vehicle and the trailer. Avoid emergency braking; otherwise slipping may cause vehicle folding and make the vehicle out of control.

Tires

- Make sure the tires have proper pressure.
- Keep the trailer tire pressure at the pressure strength defined by the trailer manufacturer according to the total weight of the trailer.

Running-in procedures

- BYD Company suggests that all new vehicles or vehicles with new parts (engine, speed reducer, differential, wheel bearing, transmission shaft, etc.) not haul trailers in the first 2,000km (kilometer).

Maintenance

- Trailer towing will increase the load of the vehicle, so it should be maintained more frequently.

How to save fuel and prolong the vehicle service life

Fuel consumption can be reduced easily and conveniently. It can also lengthen the service life of the vehicle. Following is some knowledge on reducing the fuel and repair expenditure:

- **Keep proper tire pressure.** Tire pressure insufficiency will lead to tire wear and increase the fuel consumption.
- **Do not place unnecessary**

things on the vehicle. Too heavy weight will increase the engine load and lead to fuel consumption increase.

- **Avoid long-time warming up idling.** Once the engine has entered steady state, you can start driving, but the operation should be steady. It should be noted that in cold weather, the longer time is needed to warm up the engine.
- **Accelerate slowly and steadily.** Avoid sudden start. Drive at high-speed gear as soon as possible.
- **Avoid long-time engine idling.** To wait for others when the traffic is not busy, you'd better stop the engine and, after the people have come, start it again.
- **Avoid lug down or over-speed operation of the engine.** Select proper speed gear shifts according to the road conditions.



- **Avoid frequent acceleration and deceleration.** It may increase the fuel consumption.
- **Avoid unnecessary parking or braking. Keep a steady speed.** Driving in accordance with the traffic signal lights can reduce the stop times to the minimum. Alternatively, drive on free roads with no traffic lights with a proper distance kept from the preceding vehicle to avoid emergency braking. This can also reduce brake wear.
- **Avoid areas with busy traffic or congestion as far as possible.**
- **Do not place your foot on the clutch pedal or the brake pedal.** This may produce early wear and over heat and consume large amounts of oil.

- **Position the front wheels correctly.** Avoid crushing into stones on road sides. Drive slowly on uneven roads. Improper front wheel location can not only lead to over wear of tires, but also increase the engine load and fuel consumption.
- **The chassis should be kept clean and free of mud.** This can not only reduce the vehicle weight but also prevent corrosion.
- **Adjust the vehicle to keep it in the optimal state.** Dirty air filter, improper air valve, dirty spark plug, dirty engine oil and lubricant, improperly adjusted brakes, etc. can all affect the engine performance and cause fuel waste. To prolong their useful lives, all parts should be maintained regularly. If you often drive in harsh environments, the vehicle should be maintained more often.

Friendly Tips

Do not stop the engine when going down slopes. If the engine is stopped, the power steering system and the vacuum booster won't function.

Parking brake

Setting

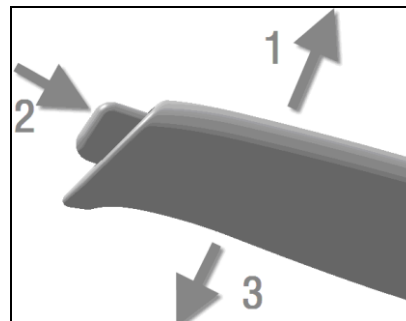

In parking, lift up the parking brake firmly to prevent the vehicle from sliding.

Applying: Lift the handle of the parking



brake. To get better retaining force, push and hold the brake pedal with your foot until the parking brake is lifted up.

Release: Lift the handle of the parking brake lightly (1), press in the lock-release button (2) and then put the parking brake down (3). The parking brake indicator will illuminate until the parking brake is released to show the parking brake has been set.

Friendly Tips

Before driving, make sure the parking brake is completely released and the parking brake indicator is out.

- For parking of automatic transmission vehicles, please shift the gear position to "P"; for parking of manual transmission vehicles, shift the gear to any non-neutral position after flameout, in order to

prevent slipping due to misoperation or parking brake failure.

- **Before driving, make sure that the parking brake is fully released, and the parking brake warning light goes out.**
- **Driving when the parking handle is not fully released will damage the brakes, tires and axles.**
- **When parking in cold region in the winter, it is recommended that do not use the parking brake system, shift the gear to any non-neutral position after flameout (manual transmission), and shift to P position (automatic transmission).**
- **When parking, please choose a suitable location; do not park the car near flammable materials, on the weeds or crop residues.**
- **If the car only uses 1 position or P position for long time parking, the slope**

of the parking shouldn't exceed 10%.

Special situation treatment while driving The engine shut down while driving

The engine shut down while driving.....

1. Please slow down the car slowly, keep moving in a straight way and drive away from the road to a safe place.
2. Turn on the emergency flashlight.
3. Start the engine again.

Friendly Tips

If the engine can not run, the power-assisting device of brake and redirector will not work. So steering and braking will be more difficult than usual.

**The car is overheated
If the coolant thermometer for the**



engine indicates overheated, or there is power loss, loud knocking, or noisy bang, that means the engine may be overheated. Please handle it as per the procedures below:

1. Drive the car away from the road, park it, and turn on the emergency flashlight. Set the transmission in the neutral position, and apply the parking brake. Stop using the air conditioning if it is running. Contact BYD authorized service station for help.
2. If there is coolant or steam spouting out of the radiator or expansion tank, please shut down the engine until it is cooled down. If no coolant or steam is spouting, just keep the engine running and make sure the cooling fan is working. If not, please turn off the ignition switch. Contact BYD

authorized service station for help.

Friendly Tips

To avoid personal injury, please keep the engine hood closed until there is no steam. The spouting of steam or coolant means high pressure.

3. Check whether there is obvious coolant leakage under the radiator, hose, and the car.

Friendly Tips

While the engine is running, please keep your hands & clothes a certain distance away from the working fan & driving belt of the engine.

4. If there is coolant leakage, please shut down the engine at once and contact the service store authorized by BYD for help.

Friendly Tips

In high temperature, the radiator cap is not allowed to be removed since the spouting high-temperature steam and liquid under pressure may cause serious damage.

If emergency towing is needed

If the car needs traction, please contact BYD authorized service station. Do not let other vehicles tract your car only with ropes or chains, which is very dangerous.

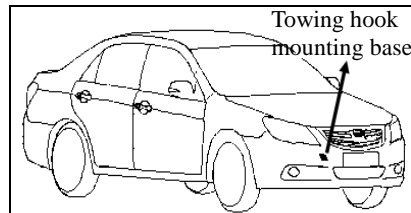



Chapter 4

Exterior Maintenance

Sheet Metal Paint Maintenance.....	4-2
Paint Maintenance Tips.....	4-3
Washing and Waxing.....	4-4



Sheet metal paint maintenance

Proper maintenance for the car can prevent corrosion for a long time.

The common causes for car corrosion:

- Saline-alkali, dust, and moisture concentrate at the inaccessible parts of bottom of the car.
- The paint film or bottom layer is scratched by slight crash or foreign bodies such as sand.

If you live in a special area or operate the car in special circumstance, please be careful:

- The dust on the road with saline-alkali or chemical substances will speed up corrosion. The air along the seacoast or in contaminated industrial park is also saline.
- High moisture will speed up corrosion, especially in the area with a temperature just over 0°C.

- Certain parts of the car are always under moisture or humidity. Even if the rest parts are kept dry, corrosion will occur.

The above items show the importance of keeping the car, especially the bottom part clean, and repairing the damaged paint film and protection film ASAP.

To avoid corrosion for BYD F0, please follow the instructions below:

Wash the car regularly. Washing your car regularly can keep it clean. But for anti-corrosion, please abide by the following points:

- In winter if you drive the car on the road with saline-alkali or live by the sea, please wash the running part of the car at least once per month to reduce corrosion.
- High pressure or steam is effective for cleaning chassis

and wheel cover. Slurry and dirt in these positions are difficult to remove, so that you need to pay extra attention as getting the slurry and crumbs wet without removing them may cause severer damage. Please avoid the dust jamming the drain hole on the lower edge of the door, sill plate, and frame, or water accumulated will lead to corrosion.

- Arrange a thorough cleaning for the chassis when winter is over.

Check the car's paint and decorative pieces.

When there is any fragment or crack on the paint film, please repair it at once to avoid the access to corrosion. If the fragments or cracks peel off the metal surface, please contact the service store authorized by BYD for repair.

Check inside of carriage. Moisture and dust will concentrate beneath the



floor mats and cause corrosion, please check the underside of the floor mats frequently and make sure it is dry. When you transport chemicals, detergent, fertilizer, or salt, please pay particular attention and use proper containers for transportation. In case of any spillage or leakage, please clean it immediately and keep dry.

Use mudguard. When driving in saline-alkali land or on the gravel road, you can use mudguard to protect the car. The mudguard with bigger size and shorter distance from the ground has better effect.

Park the car in well ventilated garage or other place with roof instead of damp or unventilated garage. To wash your car in the garage or drive on the wet or snowy road will get the garage damp and thus cause corrosion. Even though the garage is dry, the car will also get damp and suffer corrosion if it is

poorly ventilated.

Paint maintenance tips

Pay attention to the following for the maintenance and using:

- Before, during and after using the car, clear the dust on the body in time, to minimize the adsorption of dust by electrostatic on the body;
- Wash in time after raining. The rain stains on the car body gradually reduce, and the concentration of acid substances increases; if the rain stains aren't rinsed with clean water as soon as possible, the paint will be damaged;
- Before washing the car, wait until the engine cools down; do not wash the car in the burning sun or high temperature, in order to avoid detergent drying and leaving marks. Use dedicated detergent and neutral running water to wash the car, instead of alkaline washing powder, soap water and liquid detergent to prevent washing off

the grease paint and accelerating paint aging. To wash the car in a washing station, avoid the personnel using dewaxing detergent, in order to avoid paint damage. The cars driving on the coastal or polluted areas should be washed everyday;

- Scrub the car with clean soft cloth or sponge, to prevent mixing metal scraps and sand; do not wipe the car with dry cloth, towel or sponge, to avoid scratching. Wipe gently from top to bottom along the direction of water flow; do not wipe circularly or horizontally;
- For some extremely corrosive traces (such as tar, bird droppings, insects, etc.), clear away immediately. In this regard, it must be cleaned with special cleaning agents; do not scrap with blade or eliminate with gasoline, to avoid damaging the paint.

Note: Do not touch the paint with the



dirty hands or scrub the paint with oil cloth; do not put the tools stained with oil or rags containing organic solvents on the car to avoid chemical reaction.

- Do not repaint if the surface doesn't have obvious scratches, in order to prevent paint color inconsistency or poor combination;
- If the car won't be driven for a long time, park in the garage or a well-ventilated place, and cover with dedicated shield in winter. For temporary parking, choose a cool place;
- Avoid strong impact, bump and scratches to the body paint. If the paint has any scratch, depression or falling off, please repair in qualified car beauty shop in time;
- Use high quality detergent to clean the body trims; for waxing, do not wipe too much, in order to avoid penetrating the paint and exposing the prototype;
- Wax the paint from time to time for

protection and maintain in qualified car beauty shop regularly (once a quarter), to recover the gloss of the paint;

- For cleaning of light plating metal parts, use graphite cleaning agent and wax regularly for protection.

Washing and waxing Cleaning for BYD F7

Clean the car in normal way.

In the cases below, the paint film may peel off and there will be corrosion in the car body and parts. Please clean the car immediately.

- Driving along the seacoast.
- Driving on the road covered with anti-freezer.
- Stuck with coal tar, resin, bird manure, and dead insects.
- Driving in the area with heavy smoke, coal ash, dust, iron fillings, or chemical substances.
- The car is obviously covered with dust and slurry.

Manual Cleaning for BYD F7

Friendly Tips

- **Please protect your hands from hurt while cleaning the underside of the floor or chassis.**
- **Do not rinse the car with water directly if the body temperature is high, which will cause serious damage to sheet metal and paint.**

Decorative plastic pieces on

wheels: The decorative plastic pieces are easy to be damaged by organic substances. If any organic substance spills onto the decorative pieces, please wash it away by clean water and check whether the decorative pieces are hurt.

Friendly Tips

Do not install the seriously damaged decorative pieces for



plastic wheels, or they may drop off the wheel while driving and thus lead to accident.

Aluminum wheel: wash it only with neutral soap water or neutral detergent.

Bumper: be careful to wash it. Do not use detergent with grinding materials to wipe it, because its front side is soft.

Asphalt from the road: wash it by turpentine or detergent marked as non-harmful to the painted surface.

Warning

Do not use such organic substances as gas, kerosene, naphtha, and strong solvent, or you may get toxic or the car will be damaged.

Waxing for BYD F7

To keep the glossy as brand-new, we suggest you to polish and wax the car

once per month; if the car body is not quite water-resistant, please do waxing.

- Before waxing, please wash the car and dry the body even if you use the mixture of detergent and wax.
- Please use quality polish and car wax. When the polishing on the car body has been weathered seriously, please use the cleaning polish separated from the car wax. Follow the instructions and precautions from the manufacturer. The chrome plated surface also needs polishing and waxing.
- On a large surface, if the water can not form beads but stay on the surface, you shall wax the car.

Warning

When the car is placed in painting & polishing workshop

with high temperature for repainting, please remove the plastic bumper from the car, or high heat may damage the bumper.

Inside cleaning

Friendly Tips

Do not allow the water to flow onto the floor while cleaning the car, as the water may enter the audio devices or other electric appliances on the carpet (mat), which may result in malfunction of the devices and corrosion of the car body.

Carpet

Please use quality foam detergent to clean the carpet.

First use the dust collector to absorb the dust. Several kinds of foam



detergents are applicable, some are packed in aerosol can, and the rest are powder or liquid to be mixed with water for foam. Use a sponge or brush dipped with foam to wash the carpet, and the sponge or brush shall move in circle.

No clean water is needed, just keep the carpet dry. Please read the instructions for detergent and strictly follow them.

Seat Belt

The seat belt can be washed with neutral soap water or tepid water.

Use sponge or soft cloth to clean it. And check if the seat belt has evidence of abrasion or cut.

Warning

- **The seat belt can not be cleaned with coloring agent or bleach, or its strength will be weakened.**
- **Do not use the seat belt**

until it is dry.

Doors and Windows

Doors and windows can be cleaned with normal household detergent.

Warning

While cleaning the inside of the back window, please be careful not to scratch or damage the heater strip or the plug.

Please use damp and soft cloth to clean the air conditioning control panel, car stereo system, instrument panel, control panel, and switches.

Dip a clean and soft cloth into the water or tepid water, and then wipe away the dust gently.

Warning

- **Do not use organic substances (like solvent, kerosene, alcohol, or gas) and acid-base solutions,**

because these chemicals will lead to color change, taint, and peeling on the surface.

- **Before using detergent or polish, first please make sure they do not include the above substances.**
- **If you use new liquid detergent, please do not spill the liquid onto the inside surface of the car as they may contain above substance.**

Leather Ornament inside the Car
For leather ornaments, you can use neutral detergent designed for woolen fabrics to clean them. Use a soft cloth dipped with 5% of neutral detergent designed for woolen fabrics to erase the dust, and then wipe off the residual detergent with a clean wet cloth. If any part of the leather gets wet after cleaning, please wipe it dry with a clean soft cloth and keep it



in the ventilated shade for drying. It is recommended that you clean the car in BYD authorized service station.

Warning

- **If you can not wash off the dirt with neutral detergent, please use the detergent without organic solvent.**
- **Nylon brush or man-made fiber fabric will scratch the surface of the leather grain.**
- **Dirty leather ornaments will generate mold. Please try to avoid oil stain and always keep the ornaments clean.**
- **Long-time exposure to the sun may cause solidification or shrinkage to the leather surface. So please park your car in the shade especially in summer.**
- **In the hot summer, the temperature inside the car tends to rise. Do not place**

those articles made of vinyl plastic, plastic, or waxy materials on the leather ornaments, because those articles will stick to the leather in high-temperature environment.





Chapter 5

Maintenance Notice

Regular Maintenance.....	5-2
BYD F7 Passenger Car Maintenance Program.....	5-2
F7 (483QB Engine) Maintenance Schedule and Content.....	5-4
F7 (476ZQA Engine) Maintenance Schedule and Content.....	5-8



Maintenance

Regular maintenance is very important.

Here BYD recommend you to maintain F7 according to the maintenance schedule below. Regular maintenance is helpful in:

- Fuel saving
- Extension of service life
- Joy of driving
- Safe driving
- Stable driving
- Warranty compliance
- Compliance with government rules

Warning

Please maintain the car at BYD authorized service station regularly in accordance with the provisions of BYD F7 Passenger Car Maintenance and Warranty Manual.

BYD F7 Passenger Car has been designed into the vehicle of economic driving and maintenance; in order to ensure the optimized driving efficiency, it is still necessary to follow

the maintenance program.

Where can I get maintenance?

Maintenance by the local BYD authorized service station is the best. The technicians of BYD authorized service station are well-trained professionals. They will receive relevant technical journal, the essentials of maintenance, internal training programs of sales and service station and other latest information on services. The professional staff will provide you with professional service. BYD authorized service station has spent a lot of money and provided with a variety of BYD dedicated tools and repair equipment, which help to get the job done better and reduce costs.

The maintenance department of BYD authorized service station can perform all the maintenance programs, which is reliable and economical.

BYD F7 Passenger Car Maintenance Program

BYD F7 Passenger Car Maintenance Program is used to guarantee the stability of driving, reduce failures, and ensure safe and economic driving.

The maintenance intervals can be found in the schedule, and are determined according to the odometer reading or time interval, whichever comes first.

For the maintenance items that have exceeded the last period, the maintenance also should be performed at the same time interval. The maintenance interval of every item is recorded in the maintenance program.

Periodic Maintenance Table

Periodic maintenance table lists all the maintenance items necessary to keep your car always running in its best state. The maintenance shall



comply with the standards and specifications of BYD Auto Co., Ltd., and is carried out by properly trained and skilled technical personnel. BYD authorized service stations meet all these requirements.

The maintenance items, driving time and distance listed in the periodic maintenance table are prepared on the assumption that the car is used as the normal means of transport for passengers and objects.

You should also follow the advice below:

1. Avoid exceeding the loading limits, because overloading will make the engine, brakes and most other parts bear additional burden;
2. On the road allowing traffic, drive under the speed limit in accordance with the law;
3. Start your car regularly, and drive a few kilometers every time;
4. Be sure to use the recommended gasoline.



BYD genuine original parts, oil and equivalent substitutes are recommended for maintenance. These high-quality items are same with the original parts on BYD F7, which can ensure trouble-free operation of your vehicle.

F7 (483QB engine) maintenance schedule and content

Maintenance Interval	Milometer Readings or Months, Whichever Comes Earlier																
	×1,000 (km)	3	8	13	18	23	28	33	38	43	48	53	58	63	68	73	
Maintenance Items	Months	3 F i r s t T i m e	6	9	12	15	18	21	24	27	30	33	36	39	42	45	
Engine & Transmission																	
1. Check if the ribbed belt is with crack, flying chip, or abrasion and adjust its intensity		I		I		I		I		R		I		I		I	
2. Replace engine timing belt	483QB engine	Check every 20,000km; replace every 80,000km; replacement in Advance as Required															
3. Check if the ignition cable is damaged		I		I		I		I		I		I		I		I	
4. Check and replace the spark plug	General Service Condition	Common Spark Plug	Replace every 20,000km														



	n	Iridium Platinum Spark Plug	Replace every 25,000km														
	Severe service Condition		Replacement in Advance as Required														
5. Check the crankcase ventilation system (PCV valve and air hose)																	
6. Check if the water-cooling pipe is damaged and whether its connection is firm																	
7. Check the engine coolant level in the overflow pot																	
8. Replace the engine coolant			Replace every two years or 40,000km														
9. Replace the element of the air filter	General Service Condition		Clean every 2500km; replace every 15000km														
	Severe service Condition		Replacement in Advance as Required														
10. Change the engine oil	General Service Condition		R: every 5000km or six months														
	Severe service Condition		R: every 3000km														
11. Replace the engine oil filter	General Service Condition		R: every 5000km or six months														



BYD F7-1, F7-2, F7-3 Owner's Manual

		R: every 3000km													
Severe service Condition															
12. Check the battery accumulator															
13. Check the idle speed of the engine															
14. Check the ignition timing															
15. Check and adjust the valve clearance															
16. Check if the exhaust fitting is leaking air															
17. Check transmission oil cooler hose															
18. Check the control cable of the throttle valve															
19. The throttle body		Clean every 10000km													
20. The oil nozzle															
21. Check the oxygen sensor															
22. Check the three-way catalytic converter															
23. The fuel filter		Every 10,000km or six months													
24. The fuel tank cover, fuel pipe, and terminal															
25. The active carbon canister															
26. Check and change the gear	General Service Condition		R			R				R				R	



oil inside the manual transmission	Severe service Condition	R: Time Period Reduction as Required													
Chassis & Car Body															
27. Check the fixation screw fastening the chassis															
28. The brake pedal and parking brake															
29. The brake pad and brake disc															
30. Brake fluid		Replace every two years or 40,000km; check during schedule maintenance													
31. The brake pipe and hose															
32. Power-assisted steering fluid		Replace after first 40,000km, then replace every two years or 40,000km, check once every year													
33. The steering wheel and draw bar															
34. The dust helmet of transmission shaft															
35. The ball pin and dust helmet															
36. The front and back suspension system															
37. The tire and inflation pressure															
38. Check the front and back wheel alignment															
39. Check if the wheel bearing is with clearance															
40. Check the function of the clutch system and adjust the pedal travel															



41. Clutch fluid	Replace every two years or 40,000km; check during schedule maintenance														
42. Clutch system piping and hose	I		I		I		I		I		I		I		I
43. Cooling or heating system	I		I		I		I		I		I		I		I
44. The filter of air conditioning	I		R		R		R		R		R		R		R
45. The refrigerant of air conditioning	I		I		I		I		I		I		I		I
46. Check the air bag system	I		I		I		I		I		I		I		I
47. Check damage to the car body	Every year														
48. Check hood lock and fastener	Every year														

Note: 1. Meaning of symbols in the table: I = inspect, adjust or replace; R = replace, change or lubricate

2. Time period for replacement of oil filter can be reduced based on the dirt level of the gasoline engine.

Severe service condition means:

- (1) Always running in the dusty area or exposure to salty air
- (2) Always running on the bumpy, water-logging, or mountain road
- (3) Running in cold areas
- (4) The engine frequently suffers long-lasting idle running or short-distance running in the cold season
- (5) Frequently use of the brake, frequent hard braking
- (6) It often functions as a tow trailer
- (7) It is used as a taxi
- (8) Running time in urban area with busy traffic and a temperature over 32°C exceeds 50% of the total running time
- (9) Running time at the speed of 120km/h with a temperature over 32°C exceeds 50% of the total running time
- (10) Always running overload.

F7 (476ZQA engine) maintenance schedule and content

Maintenance Interval	Milometer Readings or Months, Whichever Comes Earlier												
	×1,000 (km)	3.5	1 1	18 .5	26	33.5	41	4 8. 5	56	63.5	71	78. 5	86
Maintenance Items	Months	6 First Time	1 8	30	42	54	66	7 8	90	102	114	12 6	138
Engine & Transmission													
1. Check if the ribbed belt is with crack, flying chip, or abrasion and adjust its intensity									R				
2. Check if the ignition cable is damaged													
3. Check and replace the spark plug	General Service Condition	Replace every 25,000km											
	Severe service Condition	Replacement in Advance as Required											
4. Check the crankcase ventilation system (PCV valve and air hose)													
5. Check if the water-cooling pipe is damaged and whether its connection is firm													
6. Check the engine coolant level in the expansion tank													
7. Fill gasoline detergent													



8. Replace the engine coolant		Replace every two years or 40,000km											
9. Replace the element of the air filter	General Service Condition	Clean every 7500km; replace every 20,000km											
	Severe service Condition	Replacement in Advance as Required											
10. Change the engine oil	General Service Condition	Replace during regular maintenance											
	Severe service Condition	R: every 5000km											
11. Replace the engine oil filter		Replace every time the engine oil is replaced											
12. Check the battery accumulator													
13. Check the idle speed of the engine													
14. Check if the exhaust fitting is leaking air													
15. Check the oxygen sensor													
16. Check the three-way catalytic converter													
17. The fuel filter		Replace every year or 20,000km											
18. The fuel tank cover, fuel pipe, and terminal													
19. The active carbon canister													
20. Check and change the gear oil inside the manual transmission	General Service Condition		R			R				R			
	Severe service Condition	R: Time Period Reduction as Required											



21. Check and change the gear oil inside the automatic transmission	General Service Condition	After first 55000km, check every 60000km, and replace if necessary											
	Severe service Condition	R: Time Period Reduction as Required											
Chassis & Car Body													
22. Check hood lock and fastener		Every year											
23. Check the fixation screw fastening the chassis													
24. The brake pedal and parking brake													
25. The brake pad and brake disc													
26. Brake fluid		Replace every two years or 40,000km; check during schedule maintenance											
27. The brake pipe and hose													
28. Power-assisted steering fluid		Replace after first 40,000km, then replace every two years or 40,000km, check once every year											
29. The steering wheel and draw bar													
30. The dust helmet of transmission shaft													
31. The ball pin and dust helmet													
32. The front and back suspension system													
33. The tire and inflation pressure (including TPMS)													
34. Check the front and back wheel alignment													



35. Check if the wheel bearing is with clearance	I		I		I		I		I		I	
36. Check the function of the clutch system and adjust the pedal travel	I		I		I		I		I		I	
37. Clutch fluid	Replace every two years or 40,000km; check during schedule maintenance											
38. Clutch system piping and hose	I		I		I		I		I		I	
39. Cooling or heating system	I		I		I		I		I		I	
40. The filter of air conditioning	I	I	I	I	I	I	I	I	I	I	I	I
41. The refrigerant of air conditioning	I		I		I		I		I		I	
42. Check the air bag system	I		I		I		I		I		I	
43. Check damage to the car body	Every year											

Note: 1. Meaning of symbols in the table: I = inspect, adjust or replace; R = replace, change or lubricate

2. Time period for replacement of oil filter can be reduced based on the dirt level of the gasoline engine.

Severe service condition means:

- (1) Always running in the dusty area or exposure to salty air
- (2) Always running on the bumpy, water-logging, or mountain road
- (3) Running in cold areas
- (4) The engine frequently suffers long-lasting idle running or short-distance running in the cold season
- (5) Frequently use of the brake, frequent hard braking
- (6) It often functions as a tow trailer
- (7) It is used as a taxi
- (8) Running time in urban area with busy traffic and a temperature over 32°C exceeds 50% of the total running time
- (9) Running time at the speed of 120km/h with a temperature over 32°C exceeds 50% of the total running time
- (10) Always running overload.

**Friendly Tips**

Sporadic forward shaking of TID model is normal.

Warning

Precautions for turbocharged engine:

- 476ZQA engine requires dedicated engine oil (e.g. FUCHS TITAN EM 5C 1420_TI; contact BYD authorized service station for details); do not add any other engine oil and any additives.
- Do not add any additives to the coolant, or else it will impair the corrosion resistance of the coolant and even damage the engine.
- To ensure that the engine of your car is always maintained in good working condition, be sure to add BYD approved gasoline detergent in gasoline on a regular basis. The

specific usage of gasoline detergent: the gasoline detergent should be added in each regular maintenance (including first 3500km maintenance); add 1 bottle (180ml) each time; add the gasoline detergent after filling up the tank, and do not add extra gasoline and additives before running out the tank of fuel.

- For the vehicles that the mileage exceeds 20,000 km and gasoline detergent is used for the first time, it is recommended to use 3 bottles (180ml/bottle) continuously, and then use 2 bottles continuously every 7500 km.
- In the areas that ethanol gasoline is used, it is recommended that use a bottle (180ml) of gasoline detergent every other tank of

fuel.



Chapter 6

Self Maintenance

Cooling System.....	6-2
Power Steering Fluid.....	6-5
Washer.....	6-5
Battery.....	6-6
Tire.....	6-7
Skid Chain.....	6-9

Check the following items in accordance with the usage:

1. Engine oil level - once every month;
2. Engine coolant level - once every month;
3. Windshield washing liquid - check the washing liquid in the tank once every month. If the washing liquid is frequently used because of bad weather, check the liquid level at each refueling;
4. Windshield wiper - check the wiper once every month. If the wipers can not scrape the windshield, check whether there is abrasion, cracks or other damage;
5. Automatic transmission - check the oil level once every month;
6. Brake and clutch - check the liquid level once every month;
7. Brake pedal - check whether the brake pedal operates freely;
8. Hand brake - check whether the

- handbrake lever operates freely;
9. Battery - check the battery status and terminal corrosion once every month;
10. Air-conditioning system - check the functioning of air conditioning device weekly;
11. Tires - check tire pressure monthly. Check the wear conditions of tires and whether there are embedded foreign bodies;
12. Windshield defroster - check the defroster outlet when use heater and air-conditioner every month;
13. Lights - check the status of headlights, side lights, tail lamps, high-mounted brake lamps, turn signal lamps, front fog lamps, rear fog lamps, brake lamps and license plate lamp every month;
14. Doors - check whether the luggage box cover and all doors (including rear doors) open/close freely and lock securely;
15. Horns - check whether the horns

are normal.

Friendly Tips

Do not drive the car before it is inspected, or else it will result in serious damage of the car and personal injury.

Cooling system

483QB engine

Adding engine coolant

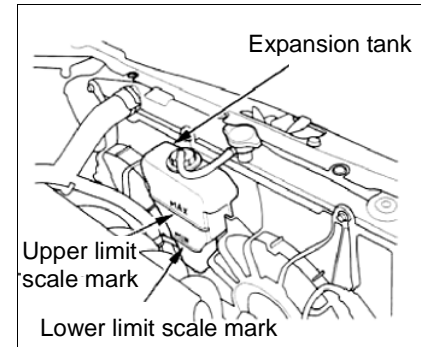

If the coolant level in the expansion tank is at or below the lower limit (MIN) scale mark, you should add the coolant to make the liquid level rise to the upper limit (MAX) scale mark. Check whether the cooling system leaks.

Only use BYD approved coolant. Do not add any extender. Do not mix coolants of different brands and models.

Warning

- **The coolant may spurt and result in severe burns if the radiator cap is opened before the engine is completely cooled down.**
- **Before opening the radiator cap, make sure that the engine and radiator have cooled down.**

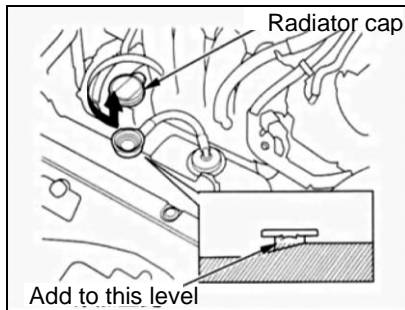

1. Confirm that the engine and radiator have cooled down;
2. Rotate the radiator cover counterclockwise (do not press down) until tightened. In this way, the residual pressure in the cooling system will be released in full;
3. Press down, and rotate counter-clockwise at the same time to remove the radiator cap;
4. The coolant level should reach the bottom of the neck of the injection port. If inadequate, add BYD approved coolant. Pour the coolant slowly to prevent overflow. If overflow occurs, immediately clear

all of the discharge, or else it will damage the components inside the cabin;

5. Put on the radiator cap, press down and rotate to the final stop position;

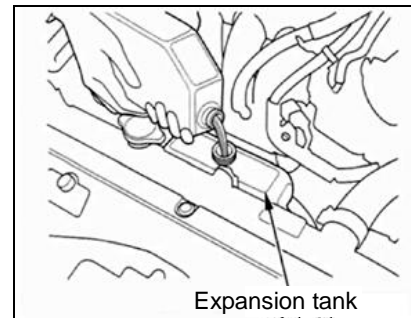

6. Fill coolant into the expansion tank, to make the liquid level rise to the upper limit (MAX) mark, and then put on the cover of expansion tank.



Friendly Tips

Do not add any rust inhibitors or other additives to the cooling system; additives may be incompatible with the coolant or engine components; it is not recommended to mix coolants of different brands and models

476ZQA engine

Adding engine coolant

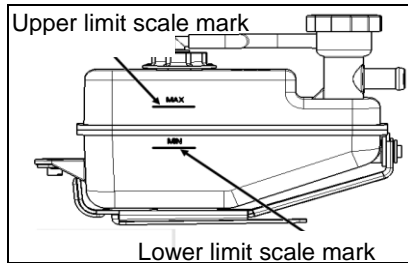

If the coolant level in the expansion tank is at or below the lower limit (MIN) scale mark, you should add the coolant to make the liquid level rise to

the upper limit (MAX) scale mark. Check whether the cooling system leaks.

Only use BYD approved coolant. Do not add any extender. Do not mix coolants of different brands and models.

Warning

- **The coolant may spurt and result in severe burns if the expansion tank is opened before the engine is completely cooled down.**
- **Before opening the expansion tank, make sure that the engine and expansion tank have cooled down.**

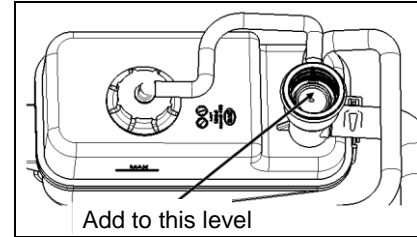

1. Confirm that the engine, radiator and expansion tank have cooled down;
2. Rotate the expansion tank cover counterclockwise (do not press down) until removed. In this way, the residual pressure in the cooling system will be released in full;
3. The coolant level should reach the bottom of the neck of the injection port. If inadequate, add BYD approved coolant. Pour the coolant slowly to prevent overflow. If overflow occurs, immediately clear all of the discharge, or else it will damage the components inside the cabin;



4. Put on the expansion tank cover, and rotate to the final stop position;

Friendly Tips

Do not add any rust inhibitors or other additives to the cooling system; additives may be incompatible with the coolant or engine components; it is not recommended to mix coolants of different brands and models

Power steering fluid

Check the level of power steering fluid at least once every six months, which should be done when the engine cools down. Check the reservoir side, and the oil level should be between the UPPER LEVEL and LOWER LEVEL. If it is below the lower limit, add power steering fluid to make the oil level rise to the upper level.

Friendly Tips

The power steering pump will be damaged if the steering wheel is

turned to the left or right end and locked there.

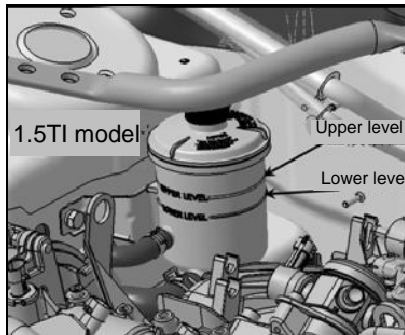

The reduction of power steering fluid level indicates that the system may leak oil; please check the oil level regularly and inspect the system as soon as possible.

Warning

Only use Mobil ATF DEXRON® - III transmission fluid or ATF transmission fluid complying with DEXRON-III as power steering

fluid, while other types of power steering fluid will damage the power steering system.

- **Be careful to add the power steering oil to avoid overflowing. Immediately clear the spilled oil, which will damage parts of the engine compartment.**
- **If you do not know how to check the fluid level and add fluid, please contact BYD authorized service station.**

Washer

Windshield washer

During normal use, check the liquid level of the windshield washer reservoir at least once every month; in case of bad weather, check the liquid level of washer reservoir when park and refuel if the washer is frequently used.

Windshield washer reservoir is located in the rear of the right front headlight of the engine compartment. Remove the cover and check the level



gauge installed on the cover to check the liquid level of the reservoir. Add high quality windshield washing liquid to improve the decontamination ability and prevent freezing in cold weather.

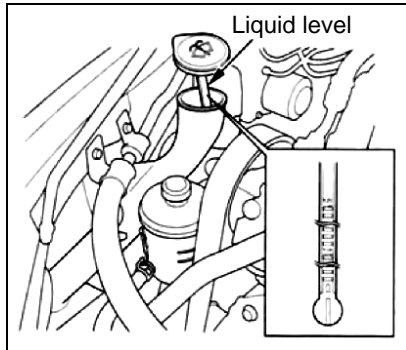

When you add the washing liquid to the reservoir again, use a clean cloth stained with windshield washing liquid to clean the wipers of the windshield. This will help make the blade of the wipers in good condition.

Warning

Do not fill engine antifreeze or vinegar and water solvent into the windshield washer reservoir. The antifreeze will damage the surface paint, the vinegar and water solvents will damage the windshield washer motor. It is recommended that use windshield washing liquid on market.

Battery

Check the status of the battery monthly. Examine the color in the indication window and the terminal corrosion.

Warning

• In normal operation, the battery may generate explosive hydrogen. Spark or open flame may cause the battery explosion, the energy of which is sufficient to cause serious

injury or even death. All sparks, open flames and flammable materials must be kept away from the battery.

- For battery maintenance, wear protective clothing and mask, or ask skilled technician to operate.
- The battery contains strong corrosive and highly toxic sulfuric acid (electrolyte). If the electrolyte splashes into eyes or on the skin, it will cause severe burns. When handling batteries or operating in the vicinity, wear protective clothing and goggles.
- Do not drink the electrolyte, or else it will cause fatal poisoning if measures aren't taken immediately.
- The battery should be placed out of the reach of the children.



Friendly Tips

The battery may produce flammable and explosive hydrogen gas.

- **When using tools, do not let the battery produce sparks.**
- **Do not smoke or light matches near the battery.**
- **The electrolyte contains toxic and corrosive sulfuric acid.**
- **Prevent electrolyte contacting with eyes, skin or clothing.**

Do not drink the electrolyte.

- **Wear safety goggles when working near the battery.**
- **Do not let children approach the battery.**

View the indicator window of the battery to check the status of the battery. The battery label is marked with the meaning of the colors of the indicator window.

If you need to connect the battery to another charger, the positive and negative cables should be disconnected to prevent damage to

the vehicle electrical system.

Tire

For safe driving, the type and size of the tires must be suitable for your vehicle, and have tread patterns in good condition and proper tire pressure. The following pages will describe how and when to check tire pressure, how to check tire damage and wear, and the method of changing tires in detail.

Warning

- **Tires of excessive wear or insufficient tire pressure will cause accidents and personal injury or death.**
- **Always comply with all instructions on the tire inflation and maintenance in the Owner's Manual.**

Inflation

Keep tires properly inflated to ensure optimized maneuverability, tire life and driving comfort. Underinflated

tires wear unevenly, the manipulation and fuel economy will be impaired, and may leak due to overheating. Hyperinflated tires make the ride uncomfortable, and the tires are easily damaged and worn unevenly due to uneven pavement.

It is recommended that inspect the tires visually everyday. If you think that certain tire is too low, test with the tire gauge immediately.

Measure the tire pressure with tire gauge at least once a month. Even if the tires are in good condition, the tire pressure also may decrease by 7~15 kPa (0.07~0.15kgf/cm²) a month. Remember to check the spare tire at the same time.

The tire pressure should be measured when the tires are in cold state. This means that wait for at least three hours after stopped and then measure the pressure. If you need to drive before measuring tire pressure, the tires still can be considered as

"cold" as long as the driving distance doesn't exceed 1.6km.

If you check tire pressure when the tires are in hot state (after driving a few kilometers), it is normal that the pressure readings are 30~40kPa (0.3~0.4kgf/cm²) higher than the readings in cold state; do not deflate in order to achieve the tire pressure reading stated in cold state, which will lead to insufficient tire pressure. You need to bring your own tire gauge and check tire pressure with it every time. In this way, you can easily determine whether the tire pressure reduction is caused by the tire or the difference between the different tire gauges.

Friendly Tips

The recommended tire pressure is attached to the tire info sign on the door frame at driver's side, which indicates the recommended cold tire pressure.

Tubeless tires feature self-enclosed function if punctured. However, since the leak is usually very slow, the leaking position should be located carefully as long as the tire pressure starts reducing.

Inspection

When checking the tire inflation every time, also check whether the tires have damage, foreign matter piercing and wearing.

You should look for:

1. Tread or side damage and heave; replace the tires in any case.
2. Scratches, cracks or broken on the sides of tires; replace the tires if tire cloth or cord thread is found.
3. Excessive tread wear.

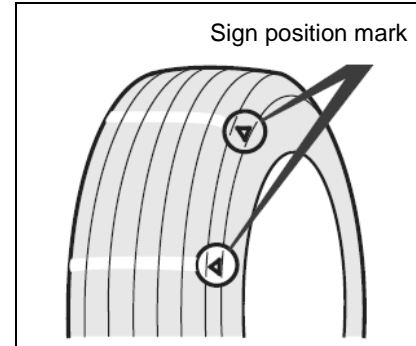

The inside of the tire is cast with wear mark. When the tread wears here, you can see a ribbon marker crossing the tire tread. This means that the tread thickness is less than 1.6mm. The tires worn to such a degree have weak adhesion on slippery roads. If the tread has three or more wear marks, the tire should be replaced.

Maintenance

In addition to proper inflation, correct wheel alignment also helps to reduce tread wear. If the tire isn't worn unevenly, please ask BYD authorized



service station to check the wheel alignment.

Before delivery of the car, the tires have been balanced; however, before the tires are worn, you may need to re-balance the tires. If you feel continuous vibration while driving, please ask BYD authorized service station to check the tires. If a tire has been repaired, the tires must be re-balanced.

Before installing new tires, be sure to let the installer balance the tires, so that the ride comfort and tire life will be increased. Dynamic balancing or "idle" balancing has been performed for the original tires of your car before delivery. It is best to ask the installer to perform the dynamic balancing when installing new tires.

Warning

Improper wheel balance weight will damage the aluminum alloy wheels of your car. Therefore, only BYD genuine original wheel

balance weight can be used to keep balance.

Replacing tires and wheels

The original tires of the car are selected to maximize vehicle performance, and provide you with the best combination of maneuverability, ride comfort and service life at the same time. Please replace with radial tires of same size, load range, rated speed and maximum cold tire pressure (marked on the tire side). Mixing radial tire and twill tire will reduce the braking capacity, driving force (traction) and steering precision of the car.

Installing improper tires will affect the flexibility and stability of the vehicle, and may lead to accidents and casualties.

It is best to replace the four tires at the same time; if it is impossible or unnecessary, replace the front tires or rear tires in pair. Replacing only one tire will affect the maneuverability of

the car.

ABS (Antilock Braking System) works through comparing wheel speeds. It is required to replace the tires with the same size as the original tires, because the tire size and structure will affect wheel speed and may lead to incoordination of the system.

If the wheels should be replaced, ensure that the specifications of the new wheels match the specifications of the original wheels. The new wheels are available in BYD authorized service station. Before replacing the tires, please consult BYD authorized service station.

Friendly Tips

Please comply with the following instruction; otherwise, it may cause serious accidents.

- **Don't use radial tire, bias belted tire or diagonal-ply tire to the car, otherwise it may cause typical operation danger and make the car out**



of control.

- **Don't use the other tire size other than the manufacturer's recommendation, otherwise it may cause a typical operation danger and make the car out of control.**

Skid chain

The skid chain is only used for emergency or driving in specific regions expressly provided by law. Skid chain should be installed on front wheels. Be careful when driving vehicle equipped with skid chain on icy road. Some skid chains may also damage the vehicle's tires, wheels, suspension and body. Please select thin skid chain to leave enough space between the tire and other parts in the wheel arch. Please carefully review and read the assembly drawings of the part and other instructions of the skid chain manufacturer. Before purchasing and installing the skid chain, please consult the BYD

authorized service station.

After installing the skid chain, drive on icy road at the speed under 30km/h. In order to minimize the wear of the tires and skid chain, do not install skid chain when driving on icy road.

Friendly Tips

- **The driving speed should not exceed 30km/h or the lower speed limit prescribed by the tire chain factory.**
- **Drive carefully and pay attention to the bulge objects, holes and a sharp turn, which may result in the vehicle jumping.**
- **When using the tire chain, please avoid a sharp turn or a locked wheel braking, which could adversely affect the operation of the car.**
- **When driving the car with tire chain, you should be careful. Reduce speed before making a turn to avoid losing control**

of the car; otherwise it may result in an accident.

Car storage

If the car will be parked for long-term (one month or more), make the following preparations. Proper preparation can help prevent deteriorating of car condition, and restart the car easily. If possible, park your car indoors.

1. Add fuel;
2. Replace the engine oil and filter;
3. Thoroughly clean and dry the body exterior;
4. Clean the interior of the car, and ensure that the carpets and pads are completely dry;
5. Release the hand brake. Set the transmission in Reverse position (manual transmission models) or in Park position (automatic transmission models);
6. Block the rear wheels;
7. If the car will be stored for a long time, use the jack to hold up the



body, so that the tires are off the ground;

8. Slightly open a window (if it is stored indoors);
9. Disconnect the negative pile head of the battery;
10. Underlay the front wiper arm with a folded towel or cloth, to avoid contacting with the windshield;
11. In order to reduce adhesions, spray silicone lubricant on all doors and luggage compartment seals, and wax the paint surface where the doors and luggage compartment seals contact;
12. Cover the body with breathable covering made of cotton or similar "porous materials". Plastic sheeting and similar non-porous materials will accumulate moisture and damage the body surface paint;
13. If possible, periodically run the engine a moment (preferably once a month).

Wiper

Notice for wiper usage

The wiper strips are wearing parts made of synthetic rubber, which will be impaired by the environment and drivers' habits; in order to ensure the wiper life and driving safety, please note the following matters.

- ※ Do not use the wipers to scrape the ice on the windshield surface; use dedicated ice scraper instead;
- ※ Do not wipe on dirty, oily or waxed windshield surface;
- ※ Keep the glass surface clean, and do not wipe the dust, sand, insects and foreign matters on the glass surface;
- ※ During car washing and body paint maintenance, it doesn't need to wax the windshield, because the wax layer will reflect light in poor lighting environment and affect the sight and driving safety. After washing, wash the wipers in purified water, and use special glass wax cleaning agent to clear

the wax on the windshield;

- ※ Do not wash the wipers with water gun directly when washing the car, to avoid damaging the wipers due to high water pressure.

Maintenance rules

- Regularly clean the windshields and wipers (once every one or two weeks)
- Even if it does not rain, it is also recommended that regular scrape the wipers (once every one or two days)
- When scrape the windshield with wipers, it is required to keep the windshield fully wet (spray the washing liquid if it doesn't rain)
- Use dedicated windscreen washer fluid to clean the windshield
- Wipe clean with a rag in time if the windshield is stained with dirt or insect's body
- If the windshield has pits

knocked by gravel, carry out maintenance in time (use windshield repair resin for pits, and replace the windshield if there are too many or too big wounds)

➤ Regularly replace the wipers (every six months)

※ When cleaning the windshield, lift the wiper arm first, and follow the specific operation below:

- A. First, turn off the car power;
- B. As shown in the figure, grasp the top of the wiper with the thumb and other fingers and carefully lift the wiper assembly

